



SPIS TREŚCI / CONTENTS

	O FIRMIE / ABOUT INTELIGHT	2
	OPRAWY OŚWIETLENIA AWARYJNEGO I EWAKUACYJNEGO / EMERGENCY AND EVACUATION LUMINAIRES	
	Orion	8
	Kasjopeja	12
	Oximia	14
	Suprema	16
	Vella	22
	Starlet Quad LED	28
	Starlet External	34
	Starlet White II	36
	MODUŁY AWARYJNE / EMERGENCY MODULES	
	Primus Tec	42
	Primus LED	44
	Primus LED HP	46
	OPRAWY PRZEMYSŁOWE / INDUSTRIAL LUMINAIRES	
	Wars LED Panel	50
	PLAFONIERY / PLAFONDS	
	Cosmic LED	56
	Milo LED	58
	OPRAWY ZEWNĘTRZNE / OUTDOOR LUMINAIRES	
	Promenad LED	62
	SYSTEM OŚWIETLENIA AWARYJNEGO / EMERGENCY LIGHTING SYSTEM	
	Wells	66
	AKCESORIA / ACCESSORIES	68
	PAKIETY AKUMULATORÓW / BATTERY PACKS	70
	PIKTOGRAMY / PICTOGRAMS	72
	OZNACZENIA / DESIGNATIONS	73
	NOTATKI / NOTES	74



FIRMA

Intelight Sp. z o.o. to polska dynamicznie rozwijająca się firma oświetleniowa. Specjalizujemy się w produkcji i dystrybucji oświetlenia awaryjnego i podstawowego w technologii LED. Stabilną pozycję osiągnęliśmy dzięki dbałości o wysoką jakość proponowanych rozwiązań oraz wsparciu, jakie zapewniamy swoim klientom. Odpowiadając na potrzeby rynkowe stale doskonalimy swoje produkty zarówno pod względem technicznym jak i jakościowym. Wszystkie oferowane wyroby spełniają surowe europejskie normy, a ich bezpieczeństwo stosowania potwierdzają odpowiednie certyfikaty.

OFERTA

W ofercie Intelight znajdują się przede wszystkim oprawy oświetlenia awaryjnego, nowoczesny system monitorowania opraw, moduły awaryjne. Drugim elementem oferty jest oświetlenie podstawowe w technologii LED, głównie oprawy wewnętrzne, biurowe i przemysłowe, a także oprawy oświetlenia zewnętrznego. Wraz z rozwojem firmy Intelight proponujemy naszym Klientom coraz szerszy asortyment.

COMPANY

Intelight Sp. z o.o. is a dynamically growing lighting company in Poland. We specialize in manufacturing and distribution of emergency lighting and general lighting in LED technology. By focusing on the quality of our solutions and by supporting our customers, we achieved a strong market position. We respond to customers' demands, this constantly improving our products, both technically and qualitatively. All our products meet the highest European standards, and their safety is confirmed by the appropriate certificates.

OFFER

Intelight Sp. z o. o. mostly offers emergency light fittings, modern wireless emergency LED lighting system and emergency power modules. A second part of our offer is composed of general LED lighting, mainly interior light fittings for offices and industrial areas, but also exterior lighting fixtures. As Intelight brand develops, we constantly broaden our range of products.





FABRYKA

Firma Intelight dysponuje nowoczesną halą produkcyjną położoną w okolicach Warszawy. Fabryka wyposażona jest w kompleksową linię do produkcji podzespołów elektronicznych oraz oświetleniowych. Posiadamy nowoczesny park maszynowy do wytwarzania elementów mechanicznych: lasery do cięcia i grawerowania, prasę krawędziową. Dostarczamy zaplecze techniczne w połączeniu z pracą działu badań i rozwoju pozwala na nieograniczone możliwości projektowe i pełną niezależność procesu produkcji oraz szybki czas realizacji zamówień.

EKOLOGIA

W swoich działaniach Intelight Sp. z o.o. przestrzega norm ekologicznych, co czyni ją przyjazną środowisku. W trosce o zasoby naturalne preferujemy w procesie produkcyjnym technologie i materiały nadające się do ponownego przetwarzania. Wybierając produkty Intelight masz pewność, że dbasz o środowisko naturalne.

TECHNOLOGICAL FOUNDATIONS

Intelight Sp. z o.o. has its own production plant near Warsaw. Factory is equipped with the complex production line for electronic components of lighting fittings. We have a modern machinery park to produce mechanical components of lighting fittings: cutting and engraving laser and press brake. Fully equipped technical back office and the engagement of research and development department provides unlimited design possibilities, full independence of production process and fast delivery time.

ECOLOGY

All company's activities are carried out with consideration of the impact on natural environment, making the company an environmentally-oriented enterprise. This includes the use of recyclable material for our production processes. Choosing Intelight products, you take care of the environment.

NAGRODY / AWARDS



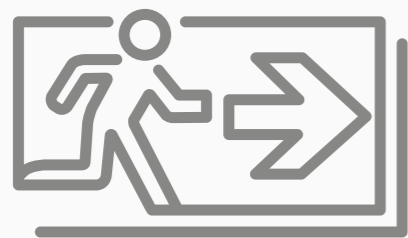

**OPRAWY
OŚWIETLENIA
AWARYJNEGO
I EWAKUACYJNEGO
EMERGENCY
AND EVACUATION
LUMINAIRES**



Orion LED



Orion LED D

Orion



- Stopień ochrony IP65
- Podstawa i klosz z wysokiej jakości poliwęglanu PC klasy V0, mleczny wysoki klosz z PMMA, opcjonalny zestaw dwustronny DS (do podświetlania piktogramów) do wersji z kloszem płaskim – płyta z PMMA, ramka stalowa malowana proszkowo
- Napięcie zasilania: 230V AC 50Hz (dla MT, AT) lub 230V AC 50Hz / 220V DC (dla CB)
- Źródło światła: diody LED
- Funkcje: A (NM) – awaryjna lub SA (M) – sieciowo-awaryjna (uniwersalna*)
- Opcje testowania: test ręczny MT, auto test AT
- Akumulatory NiCd HT lub NiMH HT z czasami autonomii 3h, ładowanie max. 24h
- Dostępna również wersja do systemów baterii centralnych CB
- Montaż: sufitowy lub ścienny, natynkowy, dostępna opcjonalna ramka do montażu sufitowego wpuszczanego
- Do oświetlania dróg ewakuacyjnych, oznaczania wyjść awaryjnych i wskazywania kierunków ewakuacji w budynkach użyteczności publicznej
- Widoczność: 20m (klosz płaski) lub 30m (zestaw dwustronny / wersja DS)
- Zakres temperatury pracy: ta 10°C ÷ 55°C, dla wersji LT ta -25°C ÷ 55°C
- Temperatura barwowa 6500K
- Współczynnik oddawania barw: Ra>=70

* Możliwość okablowania jako A - awaryjna

- IP65 protection rating
- The base and the lampshade are made of high quality, V0 class polycarbonate PC, milky high cover made of PMMA, optional double-sided set DS (for pictograms' illumination) for a version with flat cover - plate made of PMMA, frame made of steel, powder painted.
- Supply voltage: 230V AC 50Hz (for MT, AT) or 230V AC 50Hz / 220V DC (for CB)
- Light source: LED diodes
- Functions: A (NM) – non-maintained version or SA (M) – maintained (universal*) version
- Test options: manual test MT, auto test AT
- NiCd HT or NiMH batteries with autonomy times 3h, charging max. 24h
- Version for central battery CB systems also available
- Installation: ceiling or wall, surface, available optional frame for ceiling recessed installation
- For illumination of evacuation paths, marking emergency exits and showing evacuation directions in public utility buildings
- Visibility 20m or 30m (double-sided set / DS version)
- Temperature working range: t_a 10°C ÷ 55°C, for LT version t_a -25°C ÷ 55°C
- Colour temperature 6500K
- CRI index: Ra>=70
- It can be wired as the A - non-maintained version

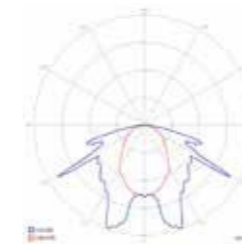

Orion LED 100

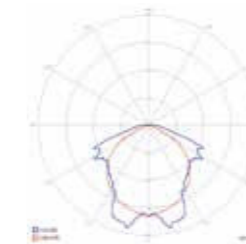

Orion LED 150

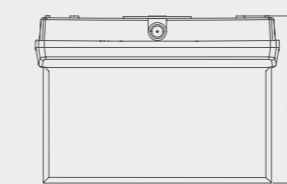

Orion LED 100 DS



Orion LED 150 DS

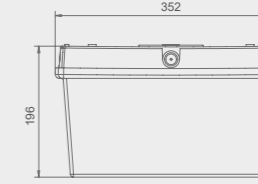

Orion LED D



Orion LED 100

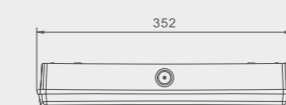

Orion LED 150

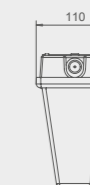

Orion LED D

Model / Model	Numer katalogowy / Catalogue number	Źródło światła / Light source	Funkcja / Function	Strumień świetlny (lm) / Luminous flux (lm)	Autonomia / Autonomy	Test* / Test*	Moc / Power
ORION LED 100 SA 3H MT	41628	LED	SA (M)	104 lm	3h	MT	4W
ORION LED 100 SA 3H AT	99905	LED	SA (M)	126 lm	3h	AT	4W
ORION LED 150 SA 3H MT	98305	LED	SA (M)	154 lm	3h	MT	7W
ORION LED 150 SA 3H AT	97245	LED	SA (M)	182 lm	3h	AT	4W
ORION LED D SA 3H AT	94941	LED	SA (M)	-	3h	AT	4W
ORION LED 150 CB	93379	LED	SA (M)	182 lm	-	CB	3,5W
ORION LED 100 CB	93412	LED	SA (M)	126 lm	-	CB	3,5W
ORION LED 100 SA 3H MT LT**	93460	LED	SA (M)	104 lm	3h	MT	7W***
ORION LED 100 SA 3H AT LT**	93391	LED	SA (M)	126 lm	3h	AT	7W***
ORION LED 150 SA 3H MT LT**	93283	LED	SA (M)	154 lm	3h	MT	10W***
ORION LED 150 SA 3H AT LT**	93387	LED	SA (M)	182 lm	3h	AT	10W***

* AT-Test automatyczny / Auto test

MT - Test ręczny / Manual test

CB - Bateria centralna / Central battery

** LT - Model przystosowany do niskich temperatur (do t_a -25°C) / Model adapted for low temperatures (up to t_a -25°C)

*** Maksymalny pobór przy min. temp. t_a -25°C wynosi 11W dla Orion LED 100 i 14W dla Orion LED 150 /

The maximum power consumption at a min temp. t_a -25°C is 11W for Orion LED 100 and 14W for Orion LED 150

AKCESORIA / ACCESSORIES

Model / Model	Numer katalogowy / Catalogue number	
	Biała / White	Czarna / Black
MASKOWNICA PT DO ORION LED 100 / FRAME FOR RECESSED INSTALLATION FOR ORION LED 100	96907	-
RAMKA DWUSTRONNA / DOUBLE-SIDED FRAME ORION LED 100	96414	-
RAMKA DWUSTRONNA / DOUBLE-SIDED FRAME ORION LED 150	96413	-
OSŁONA OCHRONNA DO ORION LED 150 / PROTECTIVE CANOPY FOR ORION LED 150	91844	91843
UCHWYT KĄTOWY DO ORION LED 150 / 0°-90° MOUNTING SUPPORT	93605	91992
ZESTAW GRZEWCZY LTR-25 8W / HEATING SET LTR-25 8W	93327	

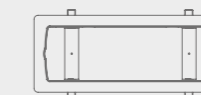

96907

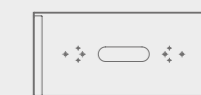

91844 / 91843

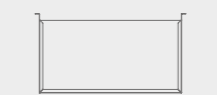

96413 / 96414



93605 / 91992



ZESTAW ORION D / KIT ORION D



OPCJA ORION D / OPTION ORION D



Model / Model	Numer katalogowy / Catalogue number	Wymiary (mm) / Dimensions (mm)
WYJŚCIE EWAKUACYJNE / EVACUATION EXIT	93321 / D1	305 x 285 x 150
WYJŚCIE W PRAWO W DÓŁ / EXIT DOWN TO THE RIGHT	39985 / D2	305 x 285 x 150
WYJŚCIE W LEWO W DÓŁ / EXIT DOWN TO THE LEFT	93322 / D3	305 x 285 x 150
WYJŚCIE W PRAWO W GÓRĘ / EXIT UP TO THE RIGHT	39986 / D4	305 x 285 x 150
WYJŚCIE W LEWO W GÓRĘ / EXIT UP TO THE LEFT	93323 / D5	305 x 285 x 150
WYJŚCIE W DÓŁ PRAWO / EXIT DOWN R	97879 / D6	305 x 285 x 150
WYJŚCIE W DÓŁ LEWO / EXIT DOWN L	93324 / D7	305 x 285 x 150
WYJŚCIE W GÓRĘ PRAWO / EXIT UP R	93325 / D8	305 x 285 x 150
WYJŚCIE W GÓRĘ LEWO / EXIT UP L	97992 / D9	305 x 285 x 150
WYJŚCIE W PRAWO / EXIT TO THE RIGHT	93318 / D10	305 x 285 x 150
WYJŚCIE W LEWO / EXIT TO THE LEFT	93317 / D11	305 x 285 x 150



Ramka dwustronna DS /
Double-sided frame DS
330x167

RAMKA DWUSTRONNA (DS) / DOUBLE-SIDED (DS) FRAME



Model / Model	Numer katalogowy / Catalogue number	Wymiary (mm) / Dimensions (mm)
WYJŚCIE EWAKUACYJNE / EVACUATION EXIT	98006 / E1	300 x 150
WYJŚCIE W PRAWO / EXIT TO THE RIGHT	98005 / E2	300 x 150
WYJŚCIE W LEWO / EXIT TO THE LEFT	98004 / E3	300 x 150
WYJŚCIE W LEWO W DÓŁ / EXIT DOWN TO THE LEFT	98003 / E4	300 x 150
WYJŚCIE W LEWO W GÓRĘ / EXIT UP TO THE LEFT	98002 / E5	300 x 150
WYJŚCIE W PRAWO W GÓRĘ / EXIT UP TO THE RIGHT	98001 / E6	300 x 150
WYJŚCIE W PRAWO W DÓŁ / EXIT DOWN TO THE RIGHT	98000 / E7	300 x 150
WYJŚCIE W DÓŁ PRAWO / EXIT DOWN R	97999 / E8	300 x 150
WYJŚCIE W DÓŁ LEWO / EXIT DOWN L	97998 / E9	300 x 150
WYJŚCIE W GÓRĘ PRAWO / EXIT UP R	97997 / E10	300 x 150
WYJŚCIE W GÓRĘ LEWO / EXIT UP L	97996 / E11	300 x 150



ZESTAW / KIT



OPCJA / OPTION

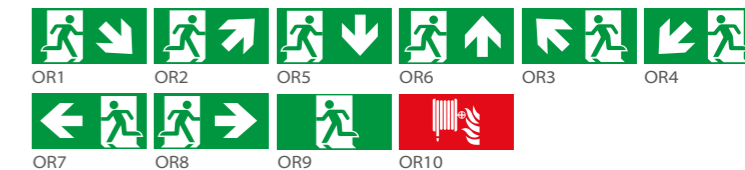

Model / Model	Numer katalogowy / Catalogue number	Wymiary (mm) / Dimensions (mm)
WYJŚCIE W PRAWO W DÓŁ / EXIT DOWN TO THE RIGHT	39980 / OR1	300 x 100
WYJŚCIE W PRAWO W GÓRĘ / EXIT UP TO THE RIGHT	39982 / OR2	300 x 100
WYJŚCIE W LEWO W GÓRĘ / EXIT UP TO THE LEFT	39983 / OR3	300 x 100
WYJŚCIE W LEWO W DÓŁ / EXIT DOWN TO THE LEFT	39981 / OR4	300 x 100
WYJŚCIE W DÓŁ / EXIT DOWN	39977 / OR5	300 x 100
WYJŚCIE W GÓRĘ / EXIT UP	98007 / OR6	300 x 100
WYJŚCIE W LEWO / EXIT TO THE LEFT	39979 / OR7	300 x 100
WYJŚCIE W PRAWO / EXIT TO THE RIGHT	39978 / OR8	300 x 100
WYJŚCIE EWAKUACYJNE / EVACUATION EXIT	39962 / OR9	300 x 100
HYDRANT WEWNĘTRZNY / FIRE HOSE REEL	93090 / OR10	300 x 100



Maskownica PT do Orion LED 100 /
Frame for recessed installation
for Orion Led 100

TABELE ODSTĘPÓW DLA PŁASKICH DRÓG EWAKUACYJNYCH / SPACING TABLE FOR FLAT EVACUATION ROUTES

ORION LED 100

Wysokość montażu (m) / Installation height (m)	1	2	3	4
2,5	2,3	6,8	4,7	1,7
3	2,2	6,7	4,7	1,6
4	1,8	6,6	4,7	0,7

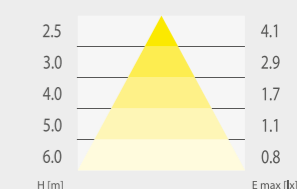

ORION LED 150

Wysokość montażu (m) / Installation height (m)	1	2	3	4
2,5	2,7	8,4	7,1	2,7
3	2,8	8,3	7,6	2,8
4	2,5	8,1	8,0	2,7

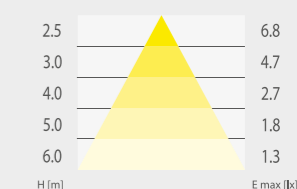



Kasjopeja



- › Stopień ochrony IP20
 - › Profil aluminiowy, płyta z PMMA
 - › Napięcie zasilania: 230V 50Hz
 - › Źródło światła: diody LED
 - › Tryb pracy: SA (M) – sieciowo-awaryjny
 - › Akumulatory Ni-Cd HT z czasem autonomii: 3h, ładowanie: 24h
 - › Montaż ścienny lub sufitowy
 - › Do wskazywania kierunków ewakuacji oraz oznaczania wyjść ewakuacyjnych w budynkach użyteczności publicznej
 - › Widoczność: 30m
 - › Współczynnik oddawania barw: Ra>=70
 - › Zakres temperatury pracy: t_a 10°C ÷ 40°C
- › IP20 protection rating
 - › Aluminium profile, PMMA board
 - › Power supply voltage: 230V 50Hz
 - › Light source: LED diodes
 - › Operation mode switch: SA (M) – maintained version
 - › Ni-Cd HT batteries with the autonomy time: 3h, charging: 24h
 - › Ceiling or wall installation
 - › For illuminating evacuation directions and designating evacuation exits in public utility buildings
 - › Visibility: 30m
 - › CRI index: Ra>=70
 - › Temperature working range: t_a 10°C ÷ 40°C

ZESTAW / KIT



OPCJA / OPTION



Model / Model	Numer katalogowy / Catalogue number	Wymiary (mm) / Dimensions (mm)
WYJŚCIE EWAKUACYJNE / EVACUATION EXIT	98006 / E1	300 x 150
WYJŚCIE W PRAWO / EXIT TO THE RIGHT	98005 / E2	300 x 150
WYJŚCIE W LEWO / EXIT TO THE LEFT	98004 / E3	300 x 150
WYJŚCIE W LEWO W DÓŁ / EXIT DOWN TO THE LEFT	98003 / E4	300 x 150
WYJŚCIE W LEWO W GÓRĘ / EXIT UP TO THE LEFT	98002 / E5	300 x 150
WYJŚCIE W PRAWO W GÓRĘ / EXIT UP TO THE RIGHT	98001 / E6	300 x 150
WYJŚCIE W PRAWO W DÓŁ / EXIT DOWN TO THE RIGHT	98000 / E7	300 x 150
WYJŚCIE W DÓŁ PRAWO / EXIT DOWN R	97999 / E8	300 x 150
WYJŚCIE W DÓŁ LEWO / EXIT DOWN L	97998 / E9	300 x 150
WYJŚCIE W GÓRĘ PRAWO / EXIT UP R	97997 / E10	300 x 150
WYJŚCIE W GÓRĘ LEWO / EXIT UP L	97996 / E11	300 x 150



Model / Model	Numer katalogowy / Catalogue number	Źródło światła / Light source	Funkcja / Function	Autonomia / Autonomy	Test / Test	Waga (kg) / Weight (kg)
KASJOPEJA LED II SA 3H MT	93331	LED	SA (M)	3h	Ręczny / Manual	1,0



Wspornik flagowy /
Flag mounting bracket



Wspornik ścienny /
Wall mounting bracket



Zestaw do montażu
zwieszanego /
Suspended mounting kit

Oximia



- ▶ Stopień ochrony IP20
- ▶ Profil stalowy malowany proszkowo, płyta z PMMA
- ▶ Napięcie zasilania: 230V 50Hz
- ▶ Źródło światła: diody LED
- ▶ Funkcje: SA (M) – sieciowo-awaryjna
- ▶ Akumulatory Ni-Cd HT z czasem autonomii: 3h, ładowanie: 24h
- ▶ Test ręczny (MT) lub test automatyczny (AT)
- ▶ Montaż sufitowy
- ▶ Do wskazywania kierunków ewakuacji oraz oznaczania wyjść ewakuacyjnych w budynkach użyteczności publicznej
- ▶ Widoczność: 30m
- ▶ Współczynnik oddawania barw: Ra>=65
- ▶ Zakres temperatury pracy: t_a 10°C ÷ 55°C
- ▶ IP20 protection rating
- ▶ Steel powder coated profile, PMMA board
- ▶ Power supply voltage: 230V 50Hz
- ▶ Light source: LED diode
- ▶ Functions: SA (M) – maintained version
- ▶ Ni-Cd HT batteries with the autonomy time: 3h, charging: 24h
- ▶ Manual test (MT) or autotest (AT)
- ▶ Ceiling installation
- ▶ For illuminating evacuation directions and designating evacuation exits in public utility buildings
- ▶ Visibility: 30m
- ▶ CRI index: Ra>=65
- ▶ Temperature working range: t_a 10°C ÷ 55°C

ZESTAW / KIT



OPCJA / OPTION



Model / Model	Numer katalogowy / Catalogue number	Wymiary (mm) / Dimensions (mm)
WYJŚCIE EWAKUACYJNE / EVACUATION EXIT	98006 / E1	300 x 150
WYJŚCIE W PRAWO / EXIT TO THE RIGHT	98005 / E2	300 x 150
WYJŚCIE W LEWO / EXIT TO THE LEFT	98004 / E3	300 x 150
WYJŚCIE W LEWO W DÓŁ / EXIT DOWN TO THE LEFT	98003 / E4	300 x 150
WYJŚCIE W LEWO W GÓRĘ / EXIT UP TO THE LEFT	98002 / E5	300 x 150
WYJŚCIE W PRAWO W GÓRĘ / EXIT UP TO THE RIGHT	98001 / E6	300 x 150
WYJŚCIE W PRAWO W DÓŁ / EXIT DOWN TO THE RIGHT	98000 / E7	300 x 150
WYJŚCIE W DÓŁ PRAWO / EXIT DOWN R	97999 / E8	300 x 150
WYJŚCIE W DÓŁ LEWO / EXIT DOWN L	97998 / E9	300 x 150
WYJŚCIE W GÓRĘ PRAWO / EXIT UP R	97997 / E10	300 x 150
WYJŚCIE W GÓRĘ LEWO / EXIT UP L	97996 / E11	300 x 150



Model / Model	Numer katalogowy / Catalogue number	Źródło światła / Light source	Funkcja / Function	Autonomia / Autonomy	Test / Test	Waga (kg) / Weight (kg)
OXIMIA 3H SA	40095	LED	SA (M)	3h	Ręczny (MT) / Manual (MT)	1,2
OXIMIA LED 3H SA AT	96329	LED	SA (M)	3h	Automatyczny (AT) / Autotest (AT)	1,2
WSPORNIK DO MONTAŻU FLAGOWEGO / FLAG MOUNTING BRACKET	97436	-	-	-	-	-
WSPORNIK DO MONTAŻU ŚCIENNEGO / WALL MOUNTING BRACKET	97437	-	-	-	-	-
ZESTAW DO MONTAŻU ZWIEZANEGO / SUSPENDED MOUNTING KIT	96314	-	-	-	-	-



Suprema



- › Stopień ochrony IP54 lub IP44*
- › Elementy konstrukcyjne oprawy wykonane z wysokiej jakości materiałów: korpus z PC/ABS, klosz z PC, płyta kierunkowa z PMMA
- › Dostępne kolory obudowy: biały lub czarny
- › Napięcie zasilania: 230V AC 50Hz (dla MT, AT i CT) lub 230V AC 50Hz / 220V DC (dla CB)
- › Źródło światła: diody LED
- › Funkcje: A (NM) – awaryjna lub SA (M) – sieciowo-awaryjna
- › Akumulatory LiFePO4 z czasami autonomii 1h, 2h lub 3h *, ładowanie 24h
- › Opcje testowania: auto test AT (możliwość ręcznego wywołania testu) lub test centralny CT (system WELLS)
- › Montaż sufitowy natynkowy lub podtynkowy, dostępne akcesoria do montażu oprawy natynkowej na ścianie, flagowo lub na wieszakach
- › Do oświetlania dróg ewakuacyjnych, wskazywania kierunków ewakuacji oraz oznaczania wyjść ewakuacyjnych w budynkach użyteczności publicznej
- › Widoczność: 30m
- › Zakres temperatury pracy: t_s 10°C ÷ 50°C
- › Temperatura barwowa 5000K
- › Współczynnik oddawania barw: Ra>=70

* - zależnie od wersji

- › IP54 or IP44 protection rating*
- › Luminaire's housing elements made of high quality materials: PC/ABS body, PC diffuser, PMMA light guide plate
- › Housing color available: white or black
- › Supply voltage: 230V AC 50Hz (for MT, AT and CT) or 230V AC 50Hz / 220V DC (for CB)
- › Light source: LED diodes
- › Functions: A (NM) – non-maintained version or SA (M) – maintained version
- › LiFePO4 batteries with autonomy times 1h, 2h or 3h *, charging 24h
- › Test options: auto test AT (possibility to manually call the test) or central test CT (WELLS system)
- › Ceiling installation, surface or recessed, surface version with wall, flag or pendant mounting possibility using additional accessories
- › For illuminating evacuation paths, indicating its directions and marking evacuation exits in public utility buildings
- › Visibility: 30m
- › Temperature working range: t_s 10°C ÷ 50°C
- › Colour temperature 5000K
- › CRI index: Ra>=70

* - depending on version

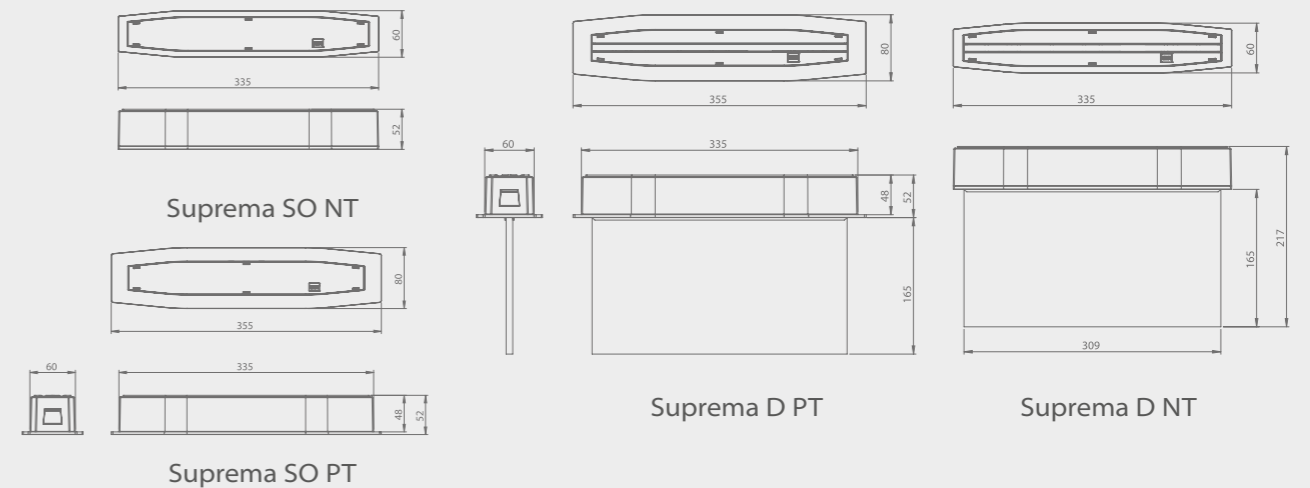

Model / Model	Numer katalogowy / Catalogue number		Optyka / Optics	Strumień świetlny / Luminous flux	Tryb / Mode	Autonomia / Autonomy	Test / Test	Stopień ochrony / Protection level	Moc / Power	Akumulator / Battery Pack
	Biała / White	Czarna / Black								
SUPREMA LED SO 150 SA 3H AT IP54 NT	94504	93980	SO	167 lm	SA (M)	3h	AT	IP54	6W	LiFePO4 6,4V 1500mAh
SUPREMA LED SO 250 SA 3H AT IP54 NT	94512	93977	SO	272 lm	SA (M)	3h	AT	IP54	8W	LiFePO4 6,4V 3000mAh
SUPREMA LED SO 350 SA 3H AT IP54 NT	94517	93976	SO	353 lm	SA (M)	3h	AT	IP54	8W	LiFePO4 6,4V 3000mAh
SUPREMA LED SO 350-P SA 3H AT IP54 NT	94521	93975	SO	407 lm	SA (M)	3h	AT	IP54	9W	LiFePO4 6,4V 3000mAh
SUPREMA LED SO 650 A 2H AT IP54 NT	94519	93974	SO	628 lm	A (NM)	2h	AT	IP54	3W	LiFePO4 6,4V 3000mAh
SUPREMA LED SO 150 CB IP54 NT	94550	94549	SO	167 lm	-	-	AT	IP54	3,5W	-
SUPREMA LED SO 350 CB IP54 NT	94579	94581	SO	353 lm	-	-	AT	IP54	6W	-

Model / Model	Numer katalogowy / Catalogue number		Optyka / Optics	Strumień świetlny / Luminous flux	Tryb / Mode	Autonomia / Autonomy	Test / Test	Stopień ochrony / Protection level	Moc / Power	Akumulator / Battery Pack
	Biała / White	Czarna / Black								
SUPREMA LED SO 150 SA 3H AT IP54 PT	94554	93970	SO	167 lm	SA (M)	3h	AT	IP54	6W	LiFePO4 6,4V 1500mAh
SUPREMA LED SO 250 SA 3H AT IP54 PT	94562	93967	SO	272 lm	SA (M)	3h	AT	IP54	8W	LiFePO4 6,4V 3000mAh
SUPREMA LED SO 350 SA 3H AT IP54 PT	94567	93966	SO	353 lm	SA (M)	3h	AT	IP54	8W	LiFePO4 6,4V 3000mAh
SUPREMA LED SO 350-P SA 3H AT IP54 PT	94571	93965	SO	407 lm	SA (M)	3h	AT	IP54	8W	LiFePO4 6,4V 3000mAh
SUPREMA LED SO 650 A 2H AT IP54 PT	94569	93963	SO	628 lm	A (NM)	2h	AT	IP54	3W	LiFePO4 6,4V 3000mAh

Model / Model	Numer katalogowy / Catalogue number		Optyka / Optics	Strumień świetlny / Luminous flux	Tryb / Mode	Autonomia / Autonomy	Test / Test	Stopień ochrony / Protection level	Moc / Power	Akumulator / Battery Pack
	Biała / White	Czarna / Black								
SUPREMA LED SC 150 SA 3H AT IP54 NT	94702	93951	SC	167 lm	SA (M)	3h	AT	IP54	6W	LiFePO4 6,4V 1500mAh
SUPREMA LED SC 250 SA 3H AT IP54 NT	94706	93949	SC	272 lm	SA (M)	3h	AT	IP54	8W	LiFePO4 6,4V 3000mAh
SUPREMA LED SC 250 CB IP54 NT	94700	94698	SC	272 lm	-	-	-	IP54	4,5W	-

Model / Model	Numer katalogowy / Catalogue number		Optyka / Optics	Strumień świetlny / Luminous flux	Tryb / Mode	Autonomia / Autonomy	Test / Test	Stopień ochrony / Protection level	Moc / Power	Akumulator / Battery Pack
	Biała / White	Czarna / Black								
SUPREMA LED SC 150 SA 3H AT IP54 PT	94752	93937	SC	167 lm	SA (M)	3h	AT	IP54	6W	LiFePO4 6,4V 1500mAh
SUPREMA LED SC 250 SA 3H AT IP54 PT	94756	93935	SC	272 lm	SA (M)	3h	AT	IP54	8W	LiFePO4 6,4V 3000mAh

SO - strefy otwarte / open spaces
SC - soczewka korytarzowa / corridor lens type
350-P - strefy otwarte (Power LED) / open zones (Power LED)
A (NM) - tryb awaryjny / non-maintained mode

SA (M) - tryb sieciowo-awaryjny / maintained mode
AT - test automatyczny / auto test
NT - montaż sufitowy / surface mounting
PT - montaż podtynkowy / recessed mounting



Suprema SO Black
zainstalowana jako NT /
NT surface installation



Suprema SO
zainstalowana jako PT /
PT recessed installation

SUPREMA LED SOH NT

Model / Model	Numer katalogowy / Catalogue number		Optyka / Optics	Strumień świetlny / Luminous flux	Tryb / Mode	Autonomia / Autonomy	Test / Test	Stopień ochrony / Protection level	Moc / Power	Akumulator / Battery Pack
	Biała / White	Czarna / Black								
SUPREMA LED SOH 250 A 3H AT IP54 NT	94523	93954	SOH	320 lm	A (NM)	3h	AT	IP54	3W	LiFEPO4 6,4V 3000mAh
SUPREMA LED SOH 400 A 2H AT IP54 NT	94525	93953	SOH	505 lm	A (NM)	2h	AT	IP54	3W	LiFEPO4 6,4V 3000mAh
SUPREMA LED SOH 400 CB IP54 NT	94580	94582	SOH	505 lm	-	-	-	IP54	6W	-

SUPREMA LED SOH PT

Model / Model	Numer katalogowy / Catalogue number		Optyka / Optics	Strumień świetlny / Luminous flux	Tryb / Mode	Autonomia / Autonomy	Test / Test	Stopień ochrony / Protection level	Moc / Power	Akumulator / Battery Pack
	Biała / White	Czarna / Black								
SUPREMA LED SOH 250 A 3H AT IP54 PT	94573	93941	SOH	320 lm	A (NM)	3h	AT	IP54	3W	LiFEPO4 6,4V 3000mAh
SUPREMA LED SOH 400 A 2H AT IP54 PT	94575	93940	SOH	505 lm	A (NM)	2h	AT	IP54	3W	LiFEPO4 6,4V 3000mAh

SUPREMA LED SCH NT

Model / Model	Numer katalogowy / Catalogue number		Optyka / Optics	Strumień świetlny / Luminous flux	Tryb / Mode	Autonomia / Autonomy	Test / Test	Stopień ochrony / Protection level	Moc / Power	Akumulator / Battery Pack
	Biała / White	Czarna / Black								
SUPREMA LED SCH 350 A 3H AT IP54 NT	94717	93948	SCH	424 lm	A (NM)	3h	AT	IP54	3W	LiFEPO4 6,4V 3000mAh
SUPREMA LED SCH 350 CB IP54 NT	94699	94696	SCH	424 lm	-	-	-	IP54	6W	-

SUPREMA LED SCH PT

Model / Model	Numer katalogowy / Catalogue number		Optyka / Optics	Strumień świetlny / Luminous flux	Tryb / Mode	Autonomia / Autonomy	Test / Test	Stopień ochrony / Protection level	Moc / Power	Akumulator / Battery Pack
	Biała / White	Czarna / Black								
SUPREMA LED SCH 350 A 3H AT IP54 PT	94767	93934	SCH	424 lm	A (NM)	3h	AT	IP54	3W	LiFEPO4 6,4V 3000mAh

SOH - strefy otwarte wysokie / open spaces high

SCH - soczewka korytarzowa do wysokich pomieszczeń / corridor lens type for high spaces

A (NM) - tryb awaryjny / non-maintained mode

AT - test automatyczny / auto test

NT - montaż sufitowy / surface mounting

PT - montaż podtynkowy / recessed mounting



SUPREMA LED SCA NT

Model / Model	Numer katalogowy / Catalogue number		Optyka / Optics	Strumień świetlny / Luminous flux	Tryb / Mode	Autonomia / Autonomy	Test / Test	Stopień ochrony / Protection level	Moc / Power	Akumulator / Battery Pack
	Biała / White	Czarna / Black								
SUPREMA LED SCA 150 SA 3H AT IP54 NT	94710	93944	SCA	167 lm	SA (M)	3h	AT	IP54	6W	LiFEPO4 6,4V 1500mAh
SUPREMA LED SCA 250 SA 3H AT IP54 NT	94714	93942	SCA	280 lm	SA (M)	3h	AT	IP54	8W	LiFEPO4 6,4V 3000mAh

SUPREMA LED SCA PT

Model / Model	Numer katalogowy / Catalogue number		Optyka / Optics	Strumień świetlny / Luminous flux	Tryb / Mode	Autonomia / Autonomy	Test / Test	Stopień ochrony / Protection level	Moc / Power	Akumulator / Battery Pack
	Biała / White	Czarna / Black								
SUPREMA LED SCA 150 SA 3H AT IP54 PT	94760	93930	SCA	167 lm	SA (M)	3h	AT	IP54	6W	LiFEPO4 6,4V 1500mAh
SUPREMA LED SCA 250 SA 3H AT IP54 PT	94764	93928	SCA	280 lm	SA (M)	3h	AT	IP54	8W	LiFEPO4 6,4V 3000mAh

SUPREMA LED SCHA NT

Model / Model	Numer katalogowy / Catalogue number		Optyka / Optics	Strumień świetlny / Luminous flux	Tryb / Mode	Autonomia / Autonomy	Test / Test	Stopień ochrony / Protection level	Moc / Power	Akumulator / Battery Pack
	Biała / White	Czarna / Black								
SUPREMA LED SCHA 250 A 3H AT IP54 NT	94719	93947	SCHA	297 lm	A (NM)	3h	AT	IP54	3W	LiFEPO4 6,4V 3000mAh
SUPREMA LED SCHA 400 A 2H AT IP54 NT	94721	93946	SCHA	459 lm	SA (M)	3h	AT	IP54	6W	LiFEPO4 6,4V 3000mAh

SUPREMA LED SCHA PT

Model / Model	Numer katalogowy / Catalogue number		Optyka / Optics	Strumień świetlny / Luminous flux	Tryb / Mode	Autonomia / Autonomy	Test / Test	Stopień ochrony / Protection level	Moc / Power	Akumulator / Battery Pack
	Biała / White	Czarna / Black								
SUPREMA LED SCHA 250 A 3H AT IP54 PT	94769	93933	SCHA	297 lm	A (NM)	3h	AT	IP54	3W	LiFEPO4 6,4V 3000mAh
SUPREMA LED SCHA 400 A 2H AT IP54 PT	94771	93932	SCHA	459 lm	SA (M)	3h	AT	IP54	6W	LiFEPO4 6,4V 3000mAh

SCHA - soczewka korytarzowa do wysokich pomieszczeń, asymetryczna / corridor lens type for high spaces, asymmetric
SCA - soczewka korytarzowa, asymetryczna / aymetric corridor lens type
A (NM) - tryb awaryjny / non-maintained mode

AT - test automatyczny / auto test
NT - montaż sufitowy / surface mounting
PT - montaż podtynkowy / recessed mounting

TABELA ODSTĘPÓW DLA PŁASKICH DRÓG EWAKUACYJNYCH / SPACING TABLE FOR FLAT EVACUATION ROUTES

SUPREMA LED SO 150

Wysokość montażu (m) / Installation height (m)				
2,5	3	7,7	8	3,2
3	3,2	8,2	8,6	3,2
4	3,1	9	9,3	3,2

SUPREMA LED SO 250

Wysokość montażu (m) / Installation height (m)				
2,5	3,7	8,6	9,2	3,7
3	3,9	9,7	9,9	3,9
4	4,1	11	11	4,1

SUPREMA LED SO 350

Wysokość montażu (m) / Installation height (m)				
2,5	3,7	8,3	10,1	4
3	4,1	9,6	11	4,4
4	4,6	11,6	12,3	4,7

SUPREMA LED SO 350-P

Wysokość montażu (m) / Installation height (m)				
2,5	4,1	8,9	10,5	4,3
3	4,6	10,4	11,4	4,6
4	4,9	12,7	12,9	5,1

SUPREMA LED SOH 400

Wysokość montażu (m) / Installation height (m)				
2,5	3,4	8,2	8,2	3,4
3	3,7	8,9	9	3,7
4	4,2	10,3	10,4	4,4

SUPREMA LED SO 650

Wysokość montażu (m) / Installation height (m)				
2,5	4	9	11,9	4,9
3	4,6	10,3	13	5,2
4	5,5	12,8	14,7	5,7



Suprema D
zainstalowana jako PT-S /
recessed mounting with sus-
pended light guide plate PT-S



Suprema D
zainstalowana jako NT-S /
surface mounting with
suspended light guide plate NT-S

PRZYKŁADOWE ROZSYŁY ŚWIATŁA DLA SOCZEWEK / EXEMPLARY LIGHT DIVISIONS FOR LENS

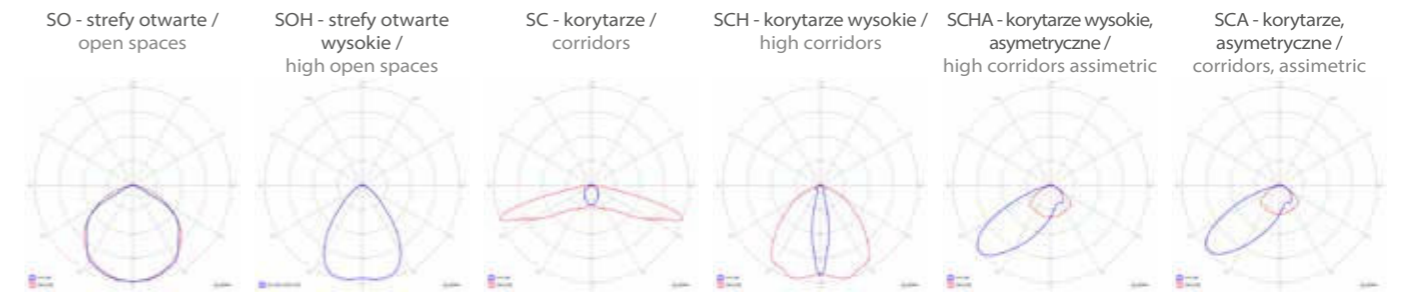

ZESTAW / KIT



OPCJA / OPTION



Model / Model	Numer katalogowy / Catalogue number	Wymiary (mm) / Dimensions (mm)
WYJŚCIE EWAKUACYJNE / EVACUATION EXIT	98006 / E1	300 x 150
WYJŚCIE W PRAWO / EXIT TO THE RIGHT	98005 / E2	300 x 150
WYJŚCIE W LEWO / EXIT TO THE LEFT	98004 / E3	300 x 150
WYJŚCIE W LEWO W DÓŁ / EXIT DOWN TO THE LEFT	98003 / E4	300 x 150
WYJŚCIE W LEWO W GÓRĘ / EXIT UP TO THE LEFT	98002 / E5	300 x 150
WYJŚCIE W PRAWO W GÓRĘ / EXIT UP TO THE RIGHT	98001 / E6	300 x 150
WYJŚCIE W PRAWO W DÓŁ / EXIT DOWN TO THE RIGHT	98000 / E7	300 x 150
WYJŚCIE W DÓŁ PRAWO / EXIT DOWN R	97999 / E8	300 x 150
WYJŚCIE W DÓŁ LEWO / EXIT DOWN L	97998 / E9	300 x 150
WYJŚCIE W GÓRĘ PRAWO / EXIT UP R	97997 / E10	300 x 150
WYJŚCIE W GÓRĘ LEWO / EXIT UP L	97996 / E11	300 x 150

SUPREMA LED D

Model / Model	Numer katalogowy / Catalogue number		Tryb / Mode	Autonomia / Autonomy	Test / Test	Stopień ochrony / Protection level	Moc / Power	Akumulator / Battery Pack
	Biała / White	Czarna / Black						
SUPREMA LED D-std SA 3H AT IP54 NT	94604	93994	SA (M)	3h	AT	IP54	5W	LiFePO4 6,4V 1500mAh
SUPREMA LED D-std SA 3H AT IP54 PT	94654	93986	SA (M)	3h	AT	IP54	5W	LiFePO4 6,4V 1500mAh
SUPREMA LED D-std SA 3H AT IP54 NT-S	94608	93961	SA (M)	3h	AT	IP54	5W	LiFePO4 6,4V 1500mAh
SUPREMA LED D-std SA 3H AT IP54 PT-S	94658	93957	SA (M)	3h	AT	IP54	5W	LiFePO4 6,4V 1500mAh
SUPREMA LED D-std CB IP54 NT	94646	94644	-	-	-	IP54	5W	-

D - kierunkowa płyta rozpraszająca / light guide plate
STD - wariant standardowy / standard variant
SA (M) - tryb sieciowo-awaryjny / maintained mode
AT - test automatyczny / auto test
NT - montaż sufitowy / surface mounting

PT - montaż podtynkowy / recessed mounting
NT-S - montaż natynkowy ze zwieszoną płytą kierunkową / surface mounting with suspended light guide plate
PT-S - montaż podtynkowy ze zwieszoną płytą kierunkową / recessed mounting with suspended light guide plate

AKCESORIA* / ACCESSORIES*

Wykonanie produktu / Product version	Numer katalogowy / Catalogue number		
	Biała / White	Czarna / Black	Srebrna / Silver
Zestaw montażu flagowego RAL 9016 / Flag mounting bracket RAL 9016	94494	93927	-
Zestaw montażu ściennego RAL 9016 / Wall mounting bracket RAL 9016	94493	93926	-
Zestaw montażu zwieszanego / Suspended mounting kit	-	-	94492

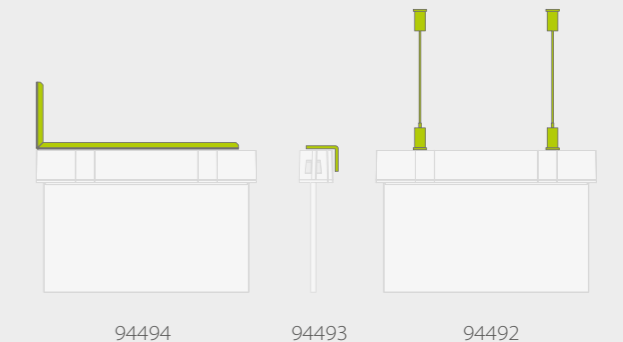

*Akcesoria do modeli natynkowych (NT) / Accessories for surface-mounting models (NT)

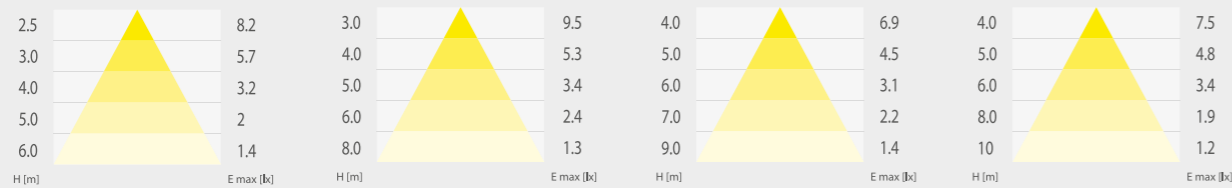

Suprema LED SO 150 Suprema LED SO 250 Suprema LED SO 350 Suprema LED SO 350-P

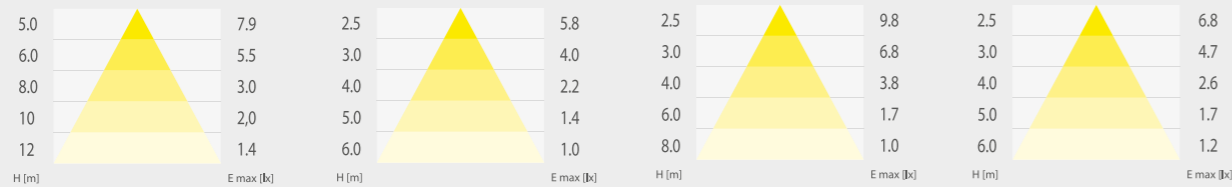

Suprema LED SO 650 Suprema LED SC 150 Suprema LED SC 250 Suprema LED SCA 150

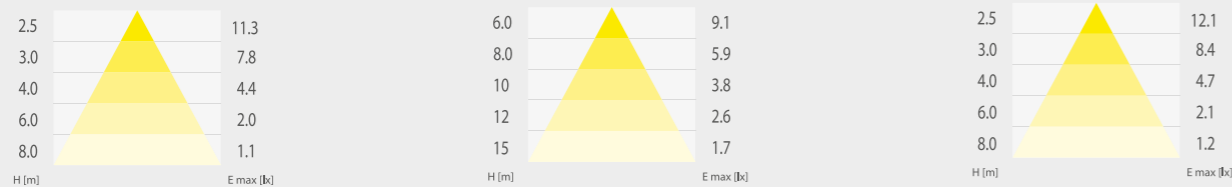

Suprema LED SCA 250 Suprema LED SCH 350 Suprema LED SCHA 250

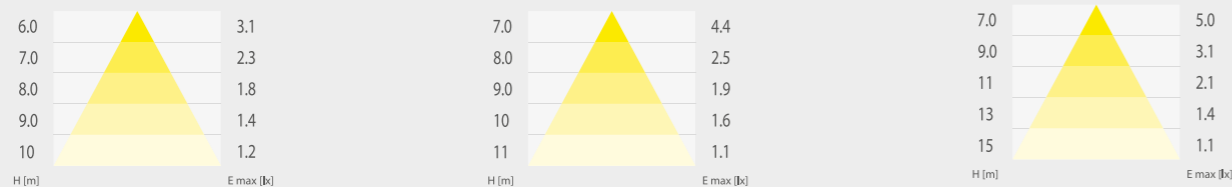

Suprema LED SCHA 400 Suprema LED SOH 250 Suprema LED SOH 400



VELLA SO
zainstalowana jako NT /
installed as NT



Vella



- › Stopień ochrony IP65 lub IP44*
- › Elementy konstrukcyjne oprawy wykonane z wysokiej jakości materiałów: korpus z PC/ABS, klosz z PC, płyta kierunkowa z PMMA
- › Napięcie zasilania: 230V AC 50Hz (dla MT, AT i CT) lub 230V AC 50Hz / 220V DC (dla CB)
- › Źródło światła: diody LED
- › Funkcje: A (NM) – awaryjna lub SA (M) – sieciowo-awaryjna
- › Akumulatory LiFePO4 i NiCd (tylko wersja ECO) z czasami autonomii 1h, 2h lub 3h *, ładowanie 24h
- › Opcje testowania: test ręczny MT, auto test AT lub test centralny CT (system WELLS)
- › Montaż: ścienny/sufitowy natynkowy lub podtynkowy, sufitowy - z opcją zwieszania
- › Do oświetlania dróg ewakuacyjnych, wskazywania kierunków ewakuacji oraz oznaczania wyjść ewakuacyjnych w budynkach użyteczności publicznej
- › Widoczność: 24m
- › Temperatura barwowa 5000K
- › Współczynnik oddawania barw: Ra>=70
- › Zakres temperatury pracy: t_a 10°C ÷ 50°C/

* - zależnie od wersji

- › IP65 or IP44 protection rating*
- › Luminaire's housing elements made of high quality materials: PC/ABS body, PC diffuser, PMMA light guide plate
- › Supply voltage: 230V AC 50Hz (for MT, AT and CT) or 230V AC 50Hz / 220V DC (for CB)
- › Light source: LED diodes
- › Functions: A (NM) – non-maintained version or SA (M) – maintained version
- › LiFePO4 and NiCd (only version ECO) batteries with autonomy times 1h, 2h or 3h *, charging 24h
- › Test options: manual test MT, auto test AT or central test CT (WELLS system)
- › Installation: wall/ceiling surface or recessed, ceiling – optionally suspended
- › For illuminating evacuation paths, indicating its directions and marking evacuation exits in public utility buildings
- › Visibility: 24m
- › Colour temperature 5000K
- › CRI index: Ra>=70
- › Temperature working range: t_a 10°C ÷ 50°C

* - depending on version

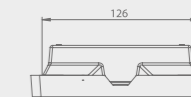
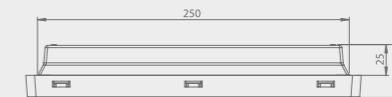

VELLA LED SO

Model / Model	Numer katalogowy / Catalogue number		Optyka / Optics	Strumień świetlny / Luminous flux	Tryb / Mode	Autonomia / Autonomy	Test / Test	Stopień ochrony / Protection level	Moc / Power	Akumulator / Battery Pack
	Biała / White	Czarna / Black								
VELLA LED ECO SO 125 A 1H MT IP44	93678	93696	SO	157 lm	A (NM)	1h	MT	IP44	1,5W	NiCd 3,6V 600mAh
VELLA LED ECO SO 125 SA 1H MT IP44	93677	93694	SO	157 lm	SA (M)	1h	MT	IP44	3,5W	NiCd 3,6V 600mAh
VELLA LED ECO SO 125 SA 3H MT IP44	93669	93681	SO	157 lm	SA (M)	3h	MT	IP44	4W	NiCd 3,6V 1200mAh
VELLA LED ECO SO 125 A 1H MT IP65	93676	93660	SO	157 lm	A (NM)	1h	MT	IP65	1,5W	NiCd 3,6V 600mAh
VELLA LED ECO SO 125 SA 1H MT IP65	93675	93658	SO	157 lm	SA (M)	1h	MT	IP65	3,5W	NiCd 3,6V 600mAh
VELLA LED ECO SO 125 A 3H MT IP65	93668	93642	SO	157 lm	A (M)	3h	MT	IP65	1,5W	NiCd 3,6V 1200mAh
VELLA LED ECO SO 125 SA 3H MT IP65	93667	93672	SO	157 lm	SA (M)	3h	MT	IP65	4W	NiCd 3,6V 1200mAh
VELLA LED ECO SO 125 SA 8H MT IP65	93673	93593	SO	157 lm	SA (M)	8h	MT	IP65	4,5W	NiMH3,6V 4000mAh
VELLA LED ECO SO 125 CB IP65	93665	93565	SO	157 lm	-	-	-	IP65	2,5W	-
VELLA LED ECO SO 250 A 1H MT IP44	93664	93692	SO	314 lm	A (NM)	1h	MT	IP44	1,5W	NiCd 3,6V 1000mAh
VELLA LED ECO SO 250 SA 3H MT IP44	93655	93683	SO	314 lm	SA (M)	3h	MT	IP44	7W	NiCd 3,6V 2500mAh
VELLA LED ECO SO 250 A 1H MT IP65	93662	93646	SO	314 lm	A (NM)	1h	MT	IP65	1,5W	NiCd 3,6V 1000mAh
VELLA LED ECO SO 250 SA 1H MT IP65	93661	93644	SO	314 lm	SA (M)	1h	MT	IP65	6W	NiCd 3,6V 1000mAh
VELLA LED ECO SO 250 SA 3H MT IP65	93653	93638	SO	314 lm	SA (M)	3h	MT	IP65	7W	NiCd 3,6V 2500mAh
VELLA LED ECO SO 250 CB IP65	93651	93556	SO	314 lm	-	-	-	IP65	5W	-
VELLA LED SO 150 SA 3H MT IP65	93504	93632	SO	190 lm	SA (M)	3h	MT	IP65	6W	LiFePO4 6,4V 1500mAh
VELLA LED SO 150 A 1H AT IP65	93547	93625	SO	190 lm	A (NM)	1h	AT	IP65	3,5W	LiFePO4 6,4V 600mAh
VELLA LED SO 150 SA 3H AT IP44	93506	93628	SO	190 lm	SA (M)	3h	AT	IP44	6W	LiFePO4 6,4V 1500mAh
VELLA LED SO 150 SA 3H AT IP65	93508	93622	SO	190 lm	SA (M)	3h	AT	IP65	5W	LiFePO4 6,4V 1500mAh
VELLA LED SO 250 SA 3H MT IP65	93516	93630	SO	331 lm	SA (M)	3h	MT	IP65	7W	LiFePO4 6,4V 3000mAh
VELLA LED SO 250 SA 3H AT IP44	93518	93592	SO	331 lm	SA (M)	3h	AT	IP44	8W	LiFePO4 6,4V 3000mAh
VELLA LED SO 250 SA 3H AT IP65	93520	93615	SO	331 lm	SA (M)	3h	AT	IP65	7W	LiFePO4 6,4V 3000mAh
VELLA LED SO 350 SA 3H AT IP65	93525	93607	SO	368 lm	SA (M)	3h	AT	IP65	8W	LiFePO4 6,4V 3000mAh
VELLA LED SO 350-P SA 3H AT IP65	93529	93599	SO	446 lm	SA (M)	3h	AT	IP65	9W	LiFePO4 6,4V 3000mAh
VELLA LED SO 650 SA 2H AT IP65	93527	93594	SO	732 lm	SA (M)	2h	AT	IP65	12W	LiFePO4 6,4V 3000mAh

VELLA LED SC

Model / Model	Numer katalogowy / Catalogue number		Optyka / Optics	Strumień świetlny / Luminous flux	Tryb / Mode	Autonomia / Autonomy	Test / Test	Stopień ochrony / Protection level	Moc / Power	Akumulator / Battery Pack
	Biała / White	Czarna / Black								
VELLA LED ECO SC 125 A 1H MT IP65	93808	93659	SC	159 lm	A (NM)	1h	MT	IP65	1W	NiCd 3,6V 600mAh
VELLA LED ECO SC 125 SA 3H MT IP65	93799	93671	SC	159 lm	SA (M)	3h	MT	IP65	4W	NiCd 3,6V 1200mAh
VELLA LED ECO SC 250 SA 3H MT IP65	93785	93789	SC	286 lm	SA (M)	3h	MT	IP65	7W	NiCd 3,6V 2500mAh
VELLA LED ECO SC 250 A 1H MT IP65	93794	93645	SC	286 lm	A (NM)	1h	MT	IP65	1,5W	NiCd 3,6V 1000mAh
VELLA LED ECO SC 250 SA 1H MT IP65	93793	93643	SC	286 lm	SA (M)	1h	MT	IP65	6W	NiCd 3,6V 1000mAh
VELLA LED SC 250 CB IP65	93700	93591	SC	331 lm	-	-	-	IP65	5W	-
VELLA LED SC 150 SA 3H AT IP65	93702	93621	SC	159 lm	SA (M)	3h	AT	IP65	7W	LiFePO4 6,4V 1500mAh
VELLA LED SC 250 SA 3H AT IP65	93706	93614	SC	287 lm	SA (M)	3h	AT	IP65	8W	LiFePO4 6,4V 3000mAh

SO - strefy otwarte / open spaces
SC - soczewka korytarzowa / corridor lens type
350-P - strefy otwarte (Power LED) / open spaces (Power LED)
A (NM) - tryb awaryjny / non-maintained mode

SA (M) - tryb sieciowo-awaryjny / maintained mode
MT - test ręczny / manual test
AT - test automatyczny / auto test
CB - bateria centralna / central battery



VELLA LED SO BLACK

VELLA LED SOH

Model / Model	Numer katalogowy / Catalogue number		Optyka / Optics	Strumień świetlny / Luminous flux	Tryb / Mode	Autonomia / Autonomy	Test / Test	Stopień ochrony / Protection level	Moc / Power	Akumulator / Battery Pack
	Biała / White	Czarna / Black								
VELLA LED SOH 250 SA 3H AT IP65	93532	93612	SOH	346 lm	SA (M)	3h	AT	IP65	9W	LiFEPO4 6,4V 3000mAh
VELLA LED SOH 250 CB IP65	93549	93590	SOH	347 lm	-	-	-	IP65	6W	-
VELLA LED SOH 400 SA 2H AT IP65	93536	93597	SOH	525 lm	SA (M)	2h	AT	IP65	10W	LiFEPO4 6,4V 3000mAh

VELLA LED SCH

Model / Model	Numer katalogowy / Catalogue number		Optyka / Optics	Strumień świetlny / Luminous flux	Tryb / Mode	Autonomia / Autonomy	Test / Test	Stopień ochrony / Protection level	Moc / Power	Akumulator / Battery Pack
	Biała / White	Czarna / Black								
VELLA LED SCH 350 SA 3H AT IP65	93718	93600	SCH	477 lm	SA (M)	3h	AT	IP65	10W	LiFEPO4 6,4V 3000mAh

VELLA LED SCA

Model / Model	Numer katalogowy / Catalogue number		Optyka / Optics	Strumień świetlny / Luminous flux	Tryb / Mode	Autonomia / Autonomy	Test / Test	Stopień ochrony / Protection level	Moc / Power	Akumulator / Battery Pack
	Biała / White	Czarna / Black								
VELLA LED SCA 150 SA 3H AT IP65	93710	93619	SC	184 lm	SA (M)	3h	AT	IP65	6W	LiFEPO4 6,4V 1500mAh
VELLA LED SCA 250 SA 3H AT IP65	93714	93610	SC	333 lm	SA (M)	3h	AT	IP65	8W	LiFEPO4 6,4V 3000mAh
VELLA LED SCA 250 CB IP65	93699	93589	SC	333 lm	-	-	-	IP65	4,5W	-

VELLA LED SCHA

Model / Model	Numer katalogowy / Catalogue number		Optyka / Optics	Strumień świetlny / Luminous flux	Tryb / Mode	Autonomia / Autonomy	Test / Test	Stopień ochrony / Protection level	Moc / Power	Akumulator / Battery Pack
	Biała / White	Czarna / Black								
VELLA LED SCHA 250 SA 3H AT IP65	93722	93608	SCHA	336 lm	SA (M)	3h	AT	IP65	9W	LiFEPO4 6,4V 3000mAh
VELLA LED SCHA 400 SA 2H AT IP65	93726	93595	SCHA	468 lm	SA (M)	2h	AT	IP65	11W	LiFEPO4 6,4V 3000mAh

SOH - strefy otwarte wysokie / open spaces high
SCHA - soczewka korytarzowa do wysokich pomieszczeń, asymetryczna / corridor lens type for high spaces, asymmetric
SCA - soczewka korytarzowa, asymetryczna / asymmetric corridor lens type
SCH - soczewka korytarzowa do wysokich pomieszczeń / corridor lens type for high spaces

A (NM) - tryb awaryjny / non-maintained mode
SA (M) - tryb sieciowo-awaryjny / maintained mode
MT - test ręczny / manual test
AT - test automatyczny / auto test
CB - bateria centralna / central battery



PRZYKŁADOWE ROZSYŁY ŚWIATŁA DLA SOCZEWEK / EXEMPLARY LIGHT DIVISIONS FOR LENS

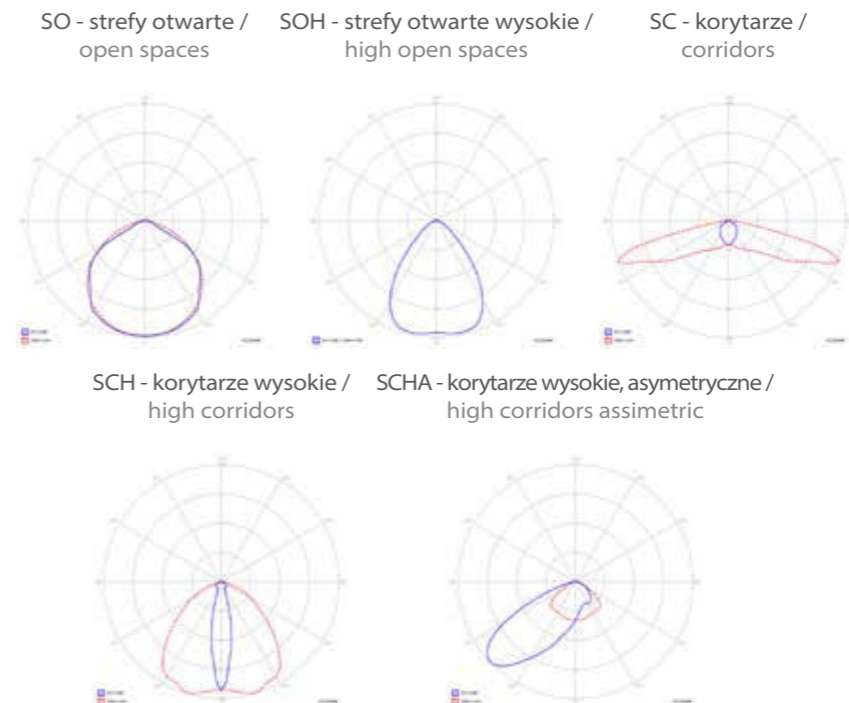



Vella LED Black
zainstalowana jako DS NT /
installed as DS NT



Vella LED
zainstalowana jako DS NT /
installed as DS NT



Vella LED
zainstalowana jako SO PT /
installed as SO PT

AKCESORIA I PIKTOGRAMY / ACCESSORIES AND PICTOGRAMS

Wykonanie produktu / Product version	Numer katalogowy / Catalogue number	Wymiary (mm) / Dimension (mm)
DS Vella - płyta PMMA / DS Vella - PMMA plate	93601	267 x 150
Wyjście w lewo / Exit left	93334	123 x 123
Wyjście w prawo / Exit right	93335	123 x 123
Strzałka lewo / prawo / góra / dół / Arrow left / right / up / down	93336	123 x 123
Strzałka ukośna góra / dół / Arrow cross up / down	93337	123 x 123
Wyjście ewakuacyjne / Evacuation exit	93338	246 x 123
Hydrant wewnętrzny / Fire hose reel	93091	246 x 123
Zestaw „PT” do montażu podtynkowego / „PT” recessed mounting kit	94491	-
Zestaw do montażu zwieszanego / Suspended mounting kit	94490	max. 2000

Wykonanie produktu / Product version	Białe / White	Czarne / Black	Srebrne / Silver	Wymiary (mm) / Dimension (mm)
Oslona ochronna / Protective canopy	91844	91843	-	373 x 171 x 65
Uchwyt kątowy / 0°-90° mounting support	93605	91992	-	202 x 45 x 66
Siatka ochronna / Protective grid	-	-	91840	340 x 200 x 62

TABELA ODSTĘPÓW DLA PŁASKICH DRÓG EWAKUACYJNYCH / SPACING TABLE FOR FLAT EVACUATION ROUTES

VELLA LED SO 150

Wysokość montażu (m) / Installation height (m)				
2,5	3,3	8,4	8,2	3,2
3	3,4	9	8,7	3,3
4	3,4	9,7	9,4	3,3

VELLA LED SC 150

Wysokość montażu (m) / Installation height (m)				
2,5	2,4	6,5	17,1	6,8
3	2,4	6,8	18,6	7
4	2,2	7	20,2	6,1

VELLA LED SO 350

Wysokość montażu (m) / Installation height (m)				
2,5	4,1	10,1	8,9	4
3	4,4	11	10,7	4,2
4	4,7	12,3	11,9	4,6

VELLA LED SO 350-P

Wysokość montażu (m) / Installation height (m)				
2,5	4,3	10,8	10,8	4,3
3	4,6	11,7	11,6	4,6
4	5,1	13,2	13	5,1

VELLA LED SO 250

Wysokość montażu (m) / Installation height (m)				
2,5	3,8	9,6	10	4
3	4,1	10,5	10,8	4,2
4	4,4	11,6	11,9	4,4

VELLA LED SC 250

Wysokość montażu (m) / Installation height (m)				
2,5	2,8	7,6	19,2	7,6
3	3	8	21,2	8,7
4	2,9	8,4	24,2	8,5

VELLA LED SOH 250

Wysokość montażu (m) / Installation height (m)				
2,5	3	7,5	7,5	3
3	3,4	8,2	8,2	3,4
4	4	9,5	9,5	4

VELLA LED SCH 350

Wysokość montażu (m) / Installation height (m)				
2,5	2,5	7,2	11,6	5,1
3	2,9	8,5	13,8	5,8
4	2,4	8,5	16,2	6,6

VELLA LED SO 650

Wysokość montażu (m) / Installation height (m)				
2,5	4,9	11,9	12,1	4,9
3	5,4	13	13,2	5,4
4	5,9	15	15	5,9

VELLA LED SOH 400

Wysokość montażu (m) / Installation height (m)				
2,5	3,5	8,6	8,6	3,5
3	3,8	9,3	9,3	3,8
4	4,4	10,8	10,8	4,4



93601

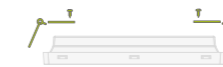

94491



94490

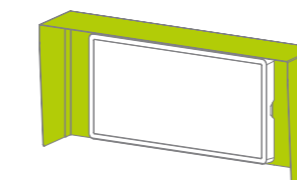

91844 / 91843



93605 / 91992

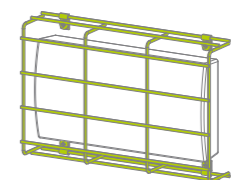

91840



PIKTOGRAMY W ZESTAWIE / PICTOGRAM IN THE KIT

Tylko do / Only for - Vella LED ECO SO 125/250, Vella LED SO 150/250





Starlet Quad LED



- › Stopień ochrony IP20 /
- › Podstawa i pokrywa wykonane z wysokiej jakości poliwęglanu (PC) lub PC/ABS /
- › Dostępne kolory obudowy: biały i czarny
- › Napięcie zasilania: 230V AC 50Hz (dla MT, AT i CT) lub 230V AC 50Hz / 220V DC (dla CB)
- › Źródło światła: diody LED wysokiej mocy i wydajności
- › Trzy wersje mocy źródeł: 1W, 2W lub 3W
- › Tryby: A (NM) – awaryjny lub SA (M) – sieciowo-awaryjny
- › Czasy autonomii: 1h, 2h lub 3h
- › Zastosowane akumulatory: NiCD lub NiMH
- › Optyka: SO – strefy otwarte, SC – korytarze, SOH – strefy otwarte wysokie lub SCH - korytarze wysokie
- › Opcje testowania: MT – test ręczny, AT – test automatyczny, CT – test centralny (Wells) lub CB – wykonanie do baterii centralnej
- › Montaż: sufitowy, natynkowy lub wpuszczany
- › Zastosowania: do oświetlania stref otwartych, pomieszczeń wysokich, dróg i wyjść ewakuacyjnych
- › Temperatura barwowa 5000K
- › Współczynnik oddawania barw: Ra>=70
- › Zakres temperatur pracy: t_a 0°C ÷ 40°C
- › IP20 protection rating
- › Housing's base and diuser made of high quality polycarbonate (PC) or PC/ABS
- › Housing's color available: white or black
- › Power supply voltage: 230V AC 50Hz (for MT, AT and CT) or 230V AC 50Hz / 220V DC (for CB)
- › Light source: efficient high power LED
- › Three light source power options: 1W, 2W or 3W
- › Functions: NM (A) – non-maintained or M (SA) – maintained version
- › Autonomy times: 1h, 2h or 3h
- › Batteries applied: NiCD or NiMH
- › Optics: SO – open spaces, SC – corridors, SOH - high open areas or SCH - high corridor
- › Testing options: MT – manual test, AT – auto test, CT – central test (Wells) or CB – central battery version
- › Installation way: on ceiling (surface) or in ceiling (recessed)
- › Lighting applications for: open spaces, high rooms, evacuation ways and exits
- › Colour temperature 5000K
- › CRI index: Ra>=70
- › Temperature working range: t_a 0°C ÷ 40°C

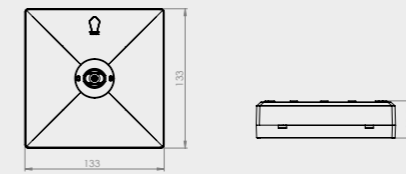

Starlet Quad LED

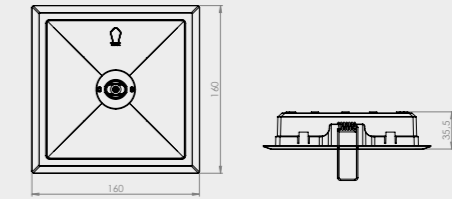

Starlet Quad LED
wersja z ramką PT*
with an accessory PT recessed installation frame*

STARLET QUAD SO

Model / Model	Numer katalogowy / Catalogue number		Moc całkowita / Total power	Optyka / Optics	Strumień świetlny sieciowy / Mains luminous flux	Strumień świetlny awaryjny / Emergency luminous flux	Tryb / Mode	Autonomia / Autonomy	Akumulator / Battery Pack	Test / Test
	Biała / White	Czarna / Black								
STARLET QUAD LED SO 150 A 1H MT	92801	92996	1W	SO	-	150 lm	A (NM)	1h	NiCd 3,6V 800mAh	MT
STARLET QUAD LED SO 150 SA 1H MT	92802	92995	3,5W	SO	150 lm	150 lm	SA (M)	1h	NiCd 3,6V 800mAh	MT
STARLET QUAD LED SO 150 SA 1H AT	92804	92994	3W	SO	150 lm	150 lm	SA (M)	1h	NiCd 3,6V 800mAh	AT
STARLET QUAD LED SO 150 SA 3H MT	92814	92993	3,5W	SO	150 lm	150 lm	SA (M)	3h	NiCd 3,6V 1700mAh	MT
STARLET QUAD LED SO 150 SA 3H AT	92816	92992	3,5W	SO	150 lm	150 lm	SA (M)	3h	NiCd 3,6V 1700mAh	AT
STARLET QUAD LED SO 150 CB	92819	92991	2W	SO	150 lm	150 lm	-	-	-	CB
STARLET QUAD LED SO 250 A 1H MT	92821	92990	1,5W	SO	-	260 lm	A (NM)	1h	NiCd 3,6V 1700mAh	MT
STARLET QUAD LED SO 250 SA 1H MT	92822	92989	6W	SO	260 lm	260 lm	SA (M)	1h	NiCd 3,6V 1700mAh	MT
STARLET QUAD LED SO 250 SA 1H AT	92824	92988	5W	SO	260 lm	260 lm	SA (M)	1h	NiCd 3,6V 1700mAh	AT
STARLET QUAD LED SO 250 SA 3H MT	92834	92987	6W	SO	260 lm	260 lm	SA (M)	3h	NiMH 3,6V 4700mAh	MT
STARLET QUAD LED SO 250 SA 3H AT	92836	92986	6W	SO	260 lm	260 lm	SA (M)	3h	NiMH 3,6V 4700mAh	AT
STARLET QUAD LED SO 250 CB	92839	92985	4W	SO	260 lm	260 lm	-	-	-	CB
STARLET QUAD LED SO 350 A 2H AT	92845	92984	2,5W	SO	-	390 lm	A (NM)	2h	NiMH 3,6V 4700mAh	AT
STARLET QUAD LED SO 350 A 3H MT	92847	92983	2,5W	SO	-	390 lm	A (NM)	3h	NiMH 3,6V 4700mAh	MT
STARLET QUAD LED SO 350 CB	92848	92982	6W	SO	390 lm	390 lm	-	-	-	CB

SO - strefy otwarte / open spaces
A (NM) - tryb awaryjny / non-maintained mode
SA (M) - tryb sieciowo-awaryjny / maintained mode

MT - test ręczny / manual test
AT - test automatyczny / auto test
CB - bateria centralna / central battery

PRZYKŁADOWE ROZSYŁY ŚWIATŁA DLA SOCZEWEK / EXEMPLARY LIGHT DIVISIONS FOR LENS

SO - strefy otwarte / open spaces

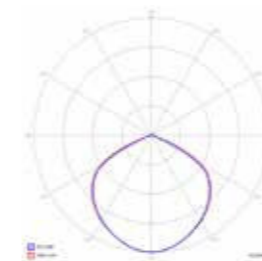

SOH - strefy otwarte wysokie / high open spaces



SC - korytarze / corridors

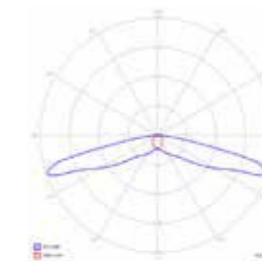

SCH - korytarze wysokie / high corridors

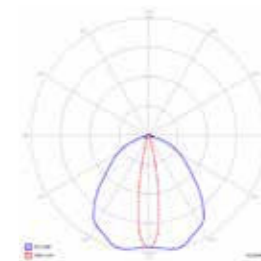



STARLET QUAD LED SC

Model / Model	Numer katalogowy / Catalogue number		Moc całkowita / Total power	Optyka / Optics	Strumień świetlny sieciowy / Mains luminous flux	Strumień świetlny awaryjny / Emergency luminous flux	Tryb / Mode	Autonomia / Autonomy	Akumulator / Battery Pack	Test / Test
	Biała / White	Czarna / Black								
STARLET QUAD LED SC 150 A 1H MT	92901	92900	1W	SC	-	140 lm	A (NM)	1h	NiCd 3,6V 800mAh	MT
STARLET QUAD LED SC 150 SA 1H MT	92902	92899	3,5W	SC	140 lm	140 lm	SA (M)	1h	NiCd 3,6V 800mAh	MT
STARLET QUAD LED SC 150 SA 1H AT	92904	92898	3W	SC	140 lm	140 lm	SA (M)	1h	NiCd 3,6V 800mAh	AT
STARLET QUAD LED SC 150 SA 3H MT	92914	92897	3,5W	SC	140 lm	140 lm	SA (M)	3h	NiCd 3,6V 1700mAh	MT
STARLET QUAD LED SC 150 SA 3H AT	92916	92896	3,5W	SC	140 lm	140 lm	SA (M)	3h	NiCd 3,6V 1700mAh	AT
STARLET QUAD LED SC 150 CB	92919	92895	2W	SC	140 lm	140 lm	-	-	-	CB
STARLET QUAD LED SC 250 A 1H MT	92921	92894	1,5W	SC	-	240 lm	A (NM)	1h	NiCd 3,6V 1700mAh	MT
STARLET QUAD LED SC 250 SA 1H MT	92922	92893	6W	SC	240 lm	240 lm	SA (M)	1h	NiCd 3,6V 1700mAh	MT
STARLET QUAD LED SC 250 SA 1H AT	92924	92892	5W	SC	240 lm	240 lm	SA (M)	1h	NiCd 3,6V 1700mAh	AT
STARLET QUAD LED SC 250 SA 3H MT	92934	92891	6W	SC	240 lm	240 lm	SA (M)	3h	NiMH 3,6V 4700mAh	MT
STARLET QUAD LED SC 250 SA 3H AT	92936	92890	6W	SC	240 lm	240 lm	SA (M)	3h	NiMH 3,6V 4700mAh	AT
STARLET QUAD LED SC 250 CB	92939	92889	4W	SC	240 lm	240 lm	-	-	-	CB
STARLET QUAD LED SC 350 A 2H AT	92945	92888	2,5W	SC	-	340 lm	A (NM)	2h	NiMH 3,6V 4700mAh	AT
STARLET QUAD LED SC 350 A 3H MT	92947	92887	2,5W	SC	-	340 lm	A (NM)	3h	NiMH 3,6V 4700mAh	MT
STARLET QUAD LED SC 350 CB	92948	92886	6W	SC	340 lm	340 lm	-	-	-	CB

SC - soczewka korytarzowa / corridor lens type
A (NM) - tryb awaryjny / non-maintained mode
SA (M) - tryb sieciowo-awaryjny / maintained mode

MT - test ręczny / manual test
AT - test automatyczny / auto test
CB - bateria centralna / central battery



AKCESORIA / ACCESSORIES

Wykonanie produktu / Product version	Numer katalogowy / Catalogue number	
	Biała / White	Czarna / Black
Ramka do montażu podtynkowego PT / PT recessed installation frame	93001	92820

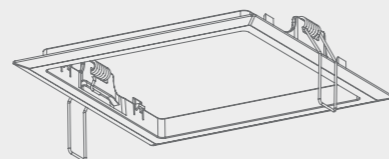

STARLET QUAD LED SOH

Model / Model	Numer katalogowy / Catalogue number		Moc całkowita / Total power	Optyka / Optics	Strumień świetlny sieciowy / Mains luminous flux	Strumień świetlny awaryjny / Emergency luminous flux	Tryb / Mode	Autonomia / Autonomy	Akumulator / Battery Pack	Test / Test
	Biała / White	Czarna / Black								
STARLET QUAD LED SOH 250 SA 1H MT	92852	92981	6W	SOH	260 lm	260 lm	SA (M)	1h	NiCd 3,6V 1700mAh	MT
STARLET QUAD LED SOH 250 SA 1H AT	92854	92980	5W	SOH	260 lm	260 lm	SA (M)	1h	NiCd 3,6V 1700mAh	AT
STARLET QUAD LED SOH 250 SA 3H MT	92864	92979	6W	SOH	260 lm	260 lm	SA (M)	3h	NiMH 3,6V 4700mAh	MT
STARLET QUAD LED SOH 250 SA 3H AT	92866	92970	6W	SOH	260 lm	260 lm	SA (M)	3h	NiMH 3,6V 4700mAh	AT
STARLET QUAD LED SOH 250 CB	92869	92950	4W	SOH	260 lm	260 lm	-	-	-	CB
STARLET QUAD LED SOH 350 A 2H AT	92875	92949	2,5W	SOH	-	390 lm	A (NM)	2h	NiMH 3,6V 4700mAh	AT
STARLET QUAD LED SOH 350 A 3H MT	92877	92940	2,5W	SOH	-	390 lm	A (NM)	3h	NiMH 3,6V 4700mAh	MT
STARLET QUAD LED SOH 350 CB	92878	92920	6W	SOH	390 lm	390 lm	-	-	-	CB

SOH - strefy otwarte wysokie / open spaces high
A (NM) - tryb awaryjny / non-maintained mode
SA (M) - tryb sieciowo-awaryjny / maintained mode

MT - test ręczny / manual test
AT - test automatyczny / auto test
CB - bateria centralna / central battery



Starlet Quad SOH

STARLET QUAD LED SCH





Model / Model	Numer katalogowy / Catalogue number		Moc całkowita / Total power	Optyka / Optics	Strumień świetlny sieciowy / Mains luminous flux	Strumień świetlny awaryjny / Emergency luminous flux	Tryb / Mode	Autonomia / Autonomy	Akumulator / Battery Pack	Test / Test
	Biała / White	Czarna / Black								
STARLET QUAD LED SCH 250 SA 1H MT	92952	92885	6W	SCH	240 lm	240 lm	SA (M)	1h	NiCd 3,6V 1700mAh	MT
STARLET QUAD LED SCH 250 SA 1H AT	92954	92884	5W	SCH	240 lm	240 lm	SA (M)	1h	NiCd 3,6V 1700mAh	AT
STARLET QUAD LED SCH 250 SA 3H MT	92964	92883	6W	SCH	240 lm	240 lm	SA (M)	3h	NiMH 3,6V 4700mAh	MT
STARLET QUAD LED SCH 250 SA 3H AT	92966	92882	6W	SCH	240 lm	240 lm	SA (M)	3h	NiMH 3,6V 4700mAh	AT
STARLET QUAD LED SCH 250 CB	92969	92881	4W	SCH	240 lm	240 lm	-	-	-	CB
STARLET QUAD LED SCH 350 A 2H AT	92975	92880	2,5W	SCH	-	400 lm	A (NM)	2h	NiMH 3,6V 4700mAh	AT
STARLET QUAD LED SCH 350 A 3H MT	92977	92879	2,5W	SCH	-	400 lm	A (NM)	3h	NiMH 3,6V 4700mAh	MT
STARLET QUAD LED SCH 350 CB	92978	92870	6W	SCH	400 lm	400 lm	-	-	-	CB

SCH - soczewka korytarzowa do wysokich pomieszczeń / corridor lens type for high spaces
A (NM) - tryb awaryjny / non-maintained mode
SA (M) - tryb sieciowo-awaryjny / maintained mode





MT - test ręczny / manual test
AT - test automatyczny / auto test
CB - bateria centralna / central battery

TABELA ODSTĘPÓW DLA PŁASKICH DRÓG EWAKUACYJNYCH / SPACING TABLE FOR FLAT EVACUATION ROUTES





STARLET QUAD SO 150

Wysokość montażu (m) / Installation height (m)				
2,5	3,2	8,0	7,9	3,2
3	3,2	8,7	8,7	3,3
4	3,1	9,3	9,3	3,1





STARLET QUAD SO 250

Wysokość montażu (m) / Installation height (m)				
2,5	3,7	8,8	9,2	3,8
3	3,9	9,8	9,2	4,1
4	4,1	11,3	11,5	4,2





STARLET QUAD SO 350

Wysokość montażu (m) / Installation height (m)				
2,5	4,1	9,3	9,9	4,1
3	4,4	10,6	11,1	4,6
4	4,9	12,6	13,0	4,9





STARLET QUAD SOH 250

Wysokość montażu (m) / Installation height (m)				
2,5	2,7	6,7	6,7	2,7
3	3,1	7,3	7,3	3,1
4	3,6	8,5	8,5	3,6





STARLET QUAD SOH 350

Wysokość montażu (m) / Installation height (m)				
2,5	3,0	7,5	7,5	3,0
3	3,4	8,2	8,2	3,4
4	4,0	9,5	9,5	4,0





STARLET QUAD SC 150

Wysokość montażu (m) / Installation height (m)				
2,5	7,2	17,8	5,1	1,8
3	7,8	19,7	5,2	1,6
4	4,9	21,9	5,0	1,1





STARLET QUAD SC 250

Wysokość montażu (m) / Installation height (m)				
2,5	8,1	19,1	6,3	2,3
3	9,2	21,7	6,4	2,3
4	9,9	25,7	6,6	2,1





STARLET QUAD SC 350

Wysokość montażu (m) / Installation height (m)				
2,5	8,7	20,3	7,2	2,6
3	9,8	22,9	7,5	2,7
4	10,9	27,8	7,7	2,7

STARLET QUAD SCH 250

Wysokość montażu (m) / Installation height (m)				
2,5	4,9	12,3	5,0	1,0
3	5,4	13,4	4,4	1,0
4	5,9	15,0	3,0	1,1

STARLET QUAD SCH 350

Wysokość montażu (m) / Installation height (m)				
2,5	5,3	12,9	5,6	1,1
3	6,1	15,3	6,5	1,2
4	6,6	17,2	3,8	1,4



Starlet Quad SO



Starlet Quad SC

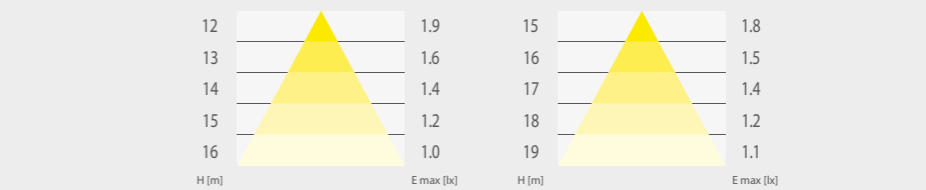
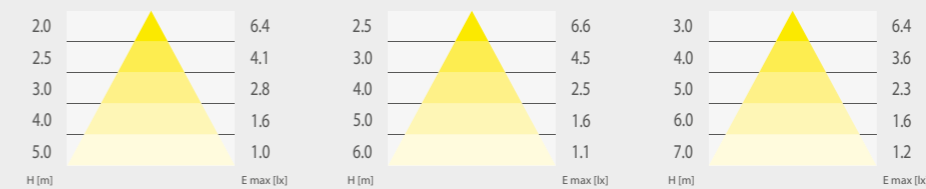
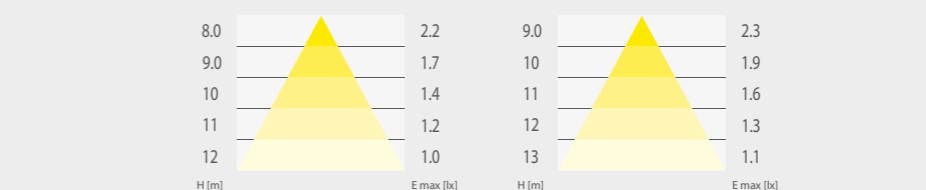
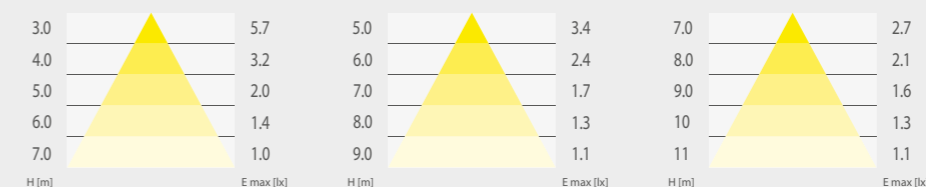

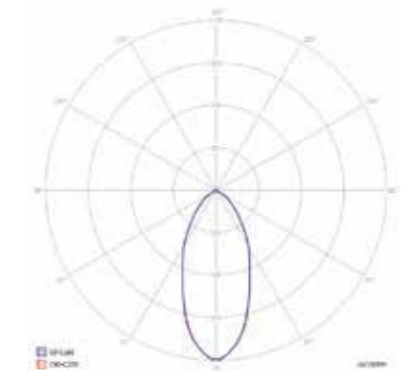
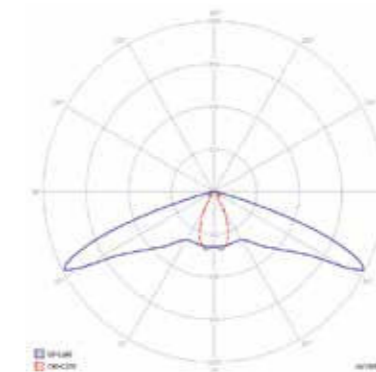
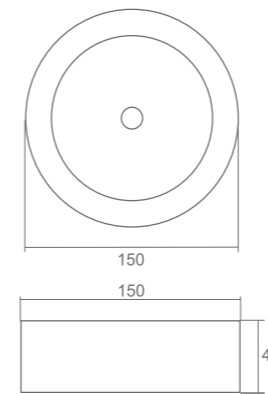

Starlet External



- › Stopień ochrony IP41
- › Obudowa z wysokiej jakości poliwęglanu
- › Dostępne kolory: biały
- › Napięcie zasilania: 230V 50Hz (MT, AT, CT) lub 230V 50Hz / 220V DC (CB)
- › Źródło światła: diody LED 3W lub 5W
- › Typ soczewki: do dróg ewakuacyjnych lub do stref otwartych
- › Funkcja: A (NM) – awaryjna lub SA (M) - sieciowo-awaryjna (uniwersalna)
- › Akumulatory Ni-Cd HT z czasem autonomii 3h; ładowanie: 24h
- › Test ręczny (MT), centralny (CT) lub autotest (AT)
- › Dostępna również wersja do systemów baterii centralnych (CB)
- › Montaż sufitowy natynkowy
- › Do oświetlania dróg i wyjść ewakuacyjnych w budynkach użyteczności publicznej
- › Typowe miejsca: korytarze, klatki schodowe, strefy otwarte
- › Temperatura barwowa 5000K
- › Współczynnik oddawania barw: Ra>=70
- › Zakres temperatury pracy: t_a 10°C ÷ 40°C

- › IP41 protection rating
- › High-quality polycarbonate enclosure
- › Available colours: white
- › Power supply voltage: 230V 50Hz (MT, AT, CT) or 230V 50Hz / 220V DC (CB)
- › Light source: 3W or 5W LED diodes
- › Type of lens: for evacuation routes or open zones
- › Function: A (NM) – non-maintained version or SA (M) - maintained version
- › Ni-Cd HT batteries with the autonomy time of 3h; charging: 24h
- › Manual test (MT), central test (CT) or autotest (AT)
- › A version for central battery (CB) systems is also available
- › Ceiling surface-mount installation
- › For illuminating evacuation routes and exits in public utility buildings
- › Typical places: corridors, staircases, open zones
- › Colour temperature 5000K
- › CRI index: Ra>=70
- › Temperature working range: t_a 10°C ÷ 40°C

Model* / Model*	Numer katalogowy / Catalogue number	Źródło światła / Light source	Strumień świetlny / Luminous flux	Funkcja** / Function**	Test / Test	Autonomia*** / Autonomy***
STARLET EXTERNAL SO 3W A 1H MT	93359	LED 3W	128 lm	A (NM)	Ręczny / Manual	1h
STARLET EXTERNAL SO 3W A 3H MT	99898	LED 3W	128 lm	A (NM)	Ręczny / Manual	3h
STARLET EXTERNAL SO 3W SA 3H AT	96318	LED 3W	175 lm	SA (M)	Autotest / Autotest	3h
STARLET EXTERNAL SO 3W SA 3H MT	96321	LED 3W	175 lm	SA (M)	Ręczny / Manual	3h
STARLET EXTERNAL SO 5W SA 3H AT	96316	LED 5W	283 lm	SA (M)	Autotest / Autotest	3h
STARLET EXTERNAL SO 5W SA 3H MT	96320	LED 5W	283 lm	SA (M)	Ręczny / Manual	3h
STARLET EXTERNAL SC 3W A 1H MT	93358	LED 3W	111 lm	A (NM)	Ręczny / Manual	1h
STARLET EXTERNAL SC 3W A 3H MT	99904	LED 3W	111 lm	A (NM)	Ręczny / Manual	3h
STARLET EXTERNAL SC 3W SA 3H AT	96325	LED 3W	143 lm	SA (M)	Autotest / Autotest	3h
STARLET EXTERNAL SC 3W SA 3H MT	96328	LED 3W	143 lm	SA (M)	Ręczny / Manual	3h
STARLET EXTERNAL SC 5W SA 3H AT	96323	LED 5W	252 lm	SA (M)	Autotest / Autotest	3h
STARLET EXTERNAL SC 5W SA 3H MT	96327	LED 5W	252 lm	SA (M)	Ręczny / Manual	3h

* SC – soczewka korytarzowa / corridor lens type, SO – soczewka do stref otwartych / open zones lens type
 ** A (NM) – awaryjna, SA (M) – sieciowo-awaryjna / A (NM) – non-maintained version, SA (M) – maintained version
 *** 1h czas autonomii dostępny jest na zamówienie / 1 h autonomy time is available on request

TABELE ODSTĘPÓW DLA PŁASKICH DRÓG EWAKUACYJNYCH / SPACING TABLE FOR FLAT EVACUATION ROUTES

STARLET EXTERNAL SC 3 W

Wysokość montażu (m) / Installation height (m)	1H	3H	AT	CB
2,5	5,3	12,9	3,1	1,3
3	5,8	14,3	3,5	1,5
4	4,0	15,6	4,2	1,6

STARLET EXTERNAL SO 3 W

Wysokość montażu (m) / Installation height (m)	1H	3H	AT	CB
2,5	2,5	6,3	6,4	2,5
3	2,8	6,9	6,9	2,8
4	3,1	7,9	7,9	3,1

STARLET EXTERNAL SC 5 W

Wysokość montażu (m) / Installation height (m)	1H	3H	AT	CB
2,5	5,6	12,9	6,0	1,5
3	6,4	14,6	5,2	1,7
4	7,5	17,6	4,7	2,0

STARLET EXTERNAL SO 5 W

Wysokość montażu (m) / Installation height (m)	1H	3H	AT	CB
2,5	2,9	7,1	7,1	2,9
3	3,3	7,9	7,9	3,3
4	3,7	9,2	9,2	3,7

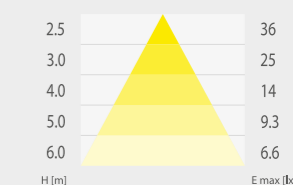
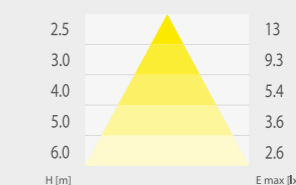
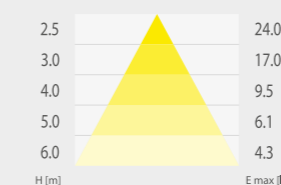

Starlet External SC 3W Starlet External SO 3W Starlet External SC 5W Starlet External SO 5W



Starlet White II SO



Starlet White II SOH



Starlet White II SC



Starlet White II Quad SO



Starlet White II Quad SOH



Starlet White II Quad SC

Starlet White II



- › Stopień ochrony IP20
 - › Obudowa elektroniki i akumulatora oraz ramka głowicy LED z poliwęglanu, radiator z aluminium
 - › Ramka głowicy LED: okrągła lub kwadratowa
 - › Napięcie zasilania: 230V 50Hz
 - › Źródło światła: LED
 - › Funkcje: A (NM) – awaryjna, SA (M) – sieciowo-awaryjna
 - › Optyka: SO – do stref otwartych, SC – korytarzowa lub SOH – do pomieszczeń wysokich
 - › Test ręczny MT lub autotest AT
 - › Akumulatory: LiFePO4
 - › Autonomia: 1h, 3h
 - › Montaż w sufitach podwieszanych
 - › Do oświetlania dróg i wyjść ewakuacyjnych w budynkach użyteczności publicznej
 - › Temperatura barwowa 5000K
 - › Współczynnik oddawania barw: Ra>=70
 - › Zakres temperatury pracy: t_s 10°C ÷ 40°C
- › IP 20 protection rating
 - › Electronics and battery housing and LED head frame made of polycarbonate, heatsink made of aluminium
 - › LED head frame: round or square
 - › Power supply voltage: 230V 50Hz
 - › Light source: LED
 - › Functions: A (NM) – non-maintained version or SA (M) – maintained version
 - › Optics: SO – for open spaces, SC – for corridors or SOH - for high areas
 - › Manual test MT or autotest AT
 - › Batteries: LiFePO4
 - › Autonomy: 1h, 3h
 - › Installation in recessed ceilings
 - › For illuminating evacuation directions and designating evacuation exits in public utility buildings
 - › Colour temperature 5000K
 - › CRI index: Ra>=70
 - › Temperature working range: t_s 10°C ÷ 40°C

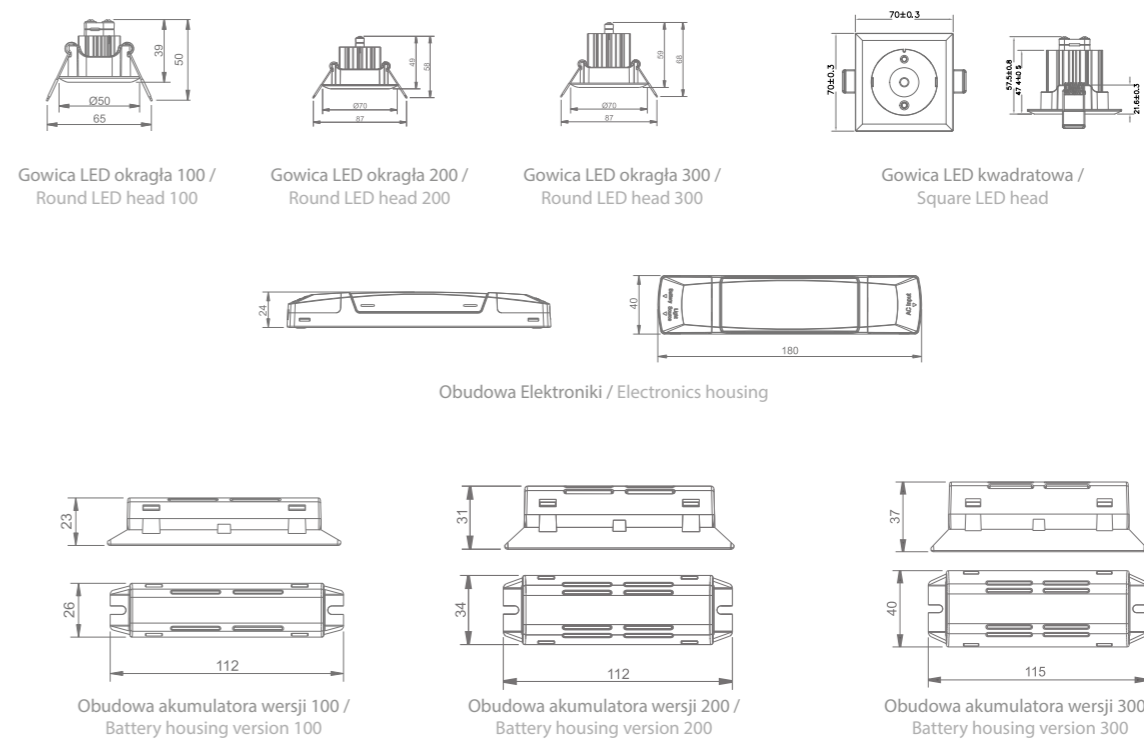

Starlet White II LED SO

Model / Model	Numer katalogowy / Catalogue number	Źródło światła / Light source	Typ soczewki / Type of lens	Strumień świetlny / Luminous flux	Funkcja / Function	Autonomia / Autonomy	Akumulator / Battery pack	Test / Test
Starlet White II LED SO 100 A 3H MT	92009	LED 1W	SO	110 lm	A (NM)	3h	LiFePO4 3.2V 1500mAh	MT
Starlet White II LED SO 200 SA 3H MT	92034	LED 2W	SO	200 lm	SA (M)	3h	LiFePO4 3.2V 3000mAh	MT
Starlet White II LED SO 200 SA 3H AT	92036	LED 2W	SO	200 lm	SA (M)	3h	LiFePO4 3.2V 3000mAh	AT
Starlet White II LED SO 300 SA 3H MT	92064	LED 3W	SO	300 lm	SA (M)	3h	LiFePO4 3.2V 5500mAh	MT
Starlet White II LED SO 300 SA 3H AT	92066	LED 3W	SO	300 lm	SA (M)	3h	LiFePO4 3.2V 5500mAh	AT

Starlet White II LED SC

Model / Model	Numer katalogowy / Catalogue number	Źródło światła / Light source	Typ soczewki / Type of lens	Strumień świetlny / Luminous flux	Funkcja / Function	Autonomia / Autonomy	Akumulator / Battery pack	Test / Test
Starlet White II LED SC 100 A 3H MT	92209	LED 1W	SC	110 lm	A (NM)	3h	LiFePO4 3.2V 1500mAh	MT
Starlet White II LED SC 200 SA 3H MT	92234	LED 2W	SC	180 lm	SA (M)	3h	LiFePO4 3.2V 3000mAh	MT
Starlet White II LED SC 200 SA 3H AT	92236	LED 2W	SC	180 lm	SA (M)	3h	LiFePO4 3.2V 3000mAh	AT
Starlet White II LED SC 300 SA 3H MT	92264	LED 3W	SC	290 lm	SA (M)	3h	LiFePO4 3.2V 5500mAh	MT
Starlet White II LED SC 300 SA 3H AT	92266	LED 3W	SC	290 lm	SA (M)	3h	LiFePO4 3.2V 5500mAh	AT

Starlet White II LED SOH

Model / Model	Numer katalogowy / Catalogue number	Źródło światła / Light source	Typ soczewki / Type of lens	Strumień świetlny / Luminous flux	Funkcja / Function	Autonomia / Autonomy	Akumulator / Battery pack	Test / Test
Starlet White II LED SOH 300 SA 3H AT	92166	LED 3W	SOH	310 lm	SA (M)	3h	LiFePO4 3.2V 5500mAh	AT

SO - strefy otwarte / open spaces
 SC - soczewka korytarzowa / corridor lens type
 SOH - strefy otwarte wysokie / high open spaces
 A (NM) - tryb awaryjny / non-maintained mode
 SA (M) - tryb sieciowo-awaryjny / maintained mode
 MT - test ręczny / manual test
 AT - test automatyczny / auto test



Starlet White II LED Quad SO

Model / Model	Numer katalogowy / Catalogue number	Źródło światła / Light source	Typ soczewki / Type of lens	Strumień świetlny / Luminous flux	Funkcja / Function	Autonomia / Autonomy	Akumulator / Battery pack	Test / Test
Starlet White II LED QUAD SO 200 SA 3H MT	92334	LED 2W	SO	200 lm	SA (M)	3h	LiFePO4 3.2V 3000mAh	MT
Starlet White II LED QUAD SO 200 SA 3H AT	92336	LED 2W	SO	200 lm	SA (M)	3h	LiFePO4 3.2V 3000mAh	AT
Starlet White II LED QUAD SO 300 SA 3H MT	92364	LED 3W	SO	300 lm	SA (M)	3h	LiFePO4 3.2V 5500mAh	MT
Starlet White II LED QUAD SO 300 SA 3H AT	92366	LED 3W	SO	300 lm	SA (M)	3h	LiFePO4 3.2V 5500mAh	AT

Starlet White II LED Quad SC

Model / Model	Numer katalogowy / Catalogue number	Źródło światła / Light source	Typ soczewki / Type of lens	Strumień świetlny / Luminous flux	Funkcja / Function	Autonomia / Autonomy	Akumulator / Battery pack	Test / Test
Starlet White II LED QUAD SC 200 SA 3H MT	92534	LED 2W	SC	180 lm	SA (M)	3h	LiFePO4 3.2V 3000mAh	MT
Starlet White II LED QUAD SC 200 SA 3H AT	92536	LED 2W	SC	180 lm	SA (M)	3h	LiFePO4 3.2V 3000mAh	AT
Starlet White II LED QUAD SC 300 SA 3H MT	92564	LED 3W	SC	290 lm	SA (M)	3h	LiFePO4 3.2V 5500mAh	MT
Starlet White II LED QUAD SC 300 SA 3H AT	92566	LED 3W	SC	290 lm	SA (M)	3h	LiFePO4 3.2V 5500mAh	AT

Starlet White II LED Quad SOH

Model / Model	Numer katalogowy / Catalogue number	Źródło światła / Light source	Typ soczewki / Type of lens	Strumień świetlny / Luminous flux	Funkcja / Function	Autonomia / Autonomy	Akumulator / Battery pack	Test / Test
Starlet White II LED QUAD SOH 300 SA 3H AT	92466	LED 3W	SOH	310 lm	SA (M)	3h	LiFePO4 3.2V 5500mAh	AT

SO - strefy otwarte / open spaces
SC - soczewka korytarzowa / corridor lens type
SOH - strefy otwarte wysokie / high open spaces
A (NM) - tryb awaryjny / non-maintained mode

SA (M) - tryb sieciowo-awaryjny / maintained mode
MT - test ręczny / manual test
AT - test automatyczny / auto test



Starlet White II Quad SO



Starlet White II Quad SC



Starlet White II Quad SOH

PRZYKŁADOWE ROZSYŁY ŚWIATŁA DLA SOCZEWEK / EXEMPLARY LIGHT DIVISIONS FOR LENS

SO - strefy otwarte / open spaces

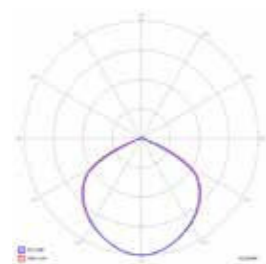

SOH - strefy otwarte wysokie / high open spaces

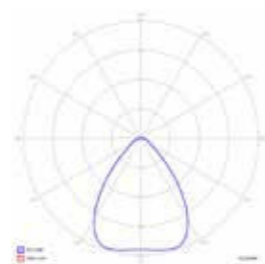

SC - korytarze / corridors

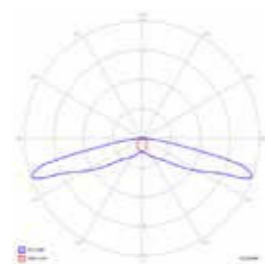

TABELE ODSTĘPÓW DLA PŁASKICH DRÓG EWAKUACYJNYCH / SPACING TABLE FOR FLAT EVACUATION ROUTES

STARLET WHITE II LED SO 100

Wysokość montażu (m) / Installation height (m)				
2,5	2,5	6,9	6,9	2,5
3	2,5	7,2	7,2	2,5
4	2,0	7,2	7,2	2,0

STARLET WHITE II LED SO 200

Wysokość montażu (m) / Installation height (m)				
2,5	3,3	8,6	8,6	3,3
3	3,4	9,2	9,2	3,4
4	3,4	9,9	9,9	3,4

STARLET WHITE II LED SO 300

Wysokość montażu (m) / Installation height (m)				
2,5	3,8	9,7	9,7	3,8
3	4,1	10,4	10,4	4,1
4	4,2	11,5	11,5	4,2

STARLET WHITE II LED SC 100

Wysokość montażu (m) / Installation height (m)				
2,5	1,3	3,1	12,3	5,1
3	1,4	3,5	13,6	5,4
4	1,5	4,1	15,1	4,1

STARLET WHITE II LED SC 200

Wysokość montażu (m) / Installation height (m)				
2,5	1,6	4,4	12,1	5,1
3	1,8	4,4	13,6	5,8
4	1,9	5,0	16,2	6,4

STARLET WHITE II LED SC 300

Wysokość montażu (m) / Installation height (m)				
2,5	1,8	6,5	12,9	5,6
3	1,8	6,3	14,8	6,4
4	2,2	5,4	17,6	7,2

STARLET WHITE II LED SOH 300

Wysokość montażu (m) / Installation height (m)				
2,5	2,9	6,7	6,7	2,9
3	3,2	7,8	7,8	3,2
4	3,6	9,0	9,0	3,6

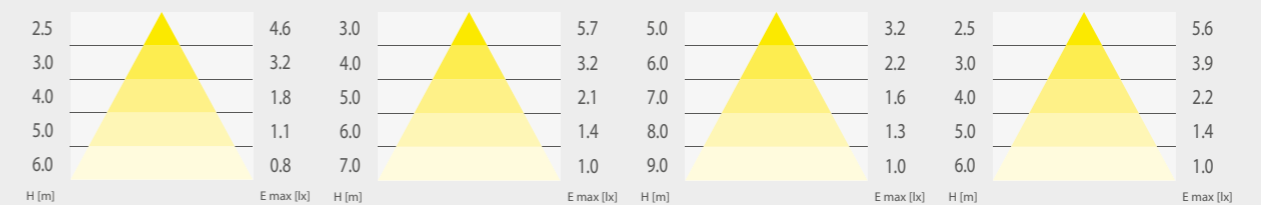

Starlet White II LED SO 100

Starlet White II LED SO 200

Starlet White II LED SO 300

Starlet White II LED SC 100

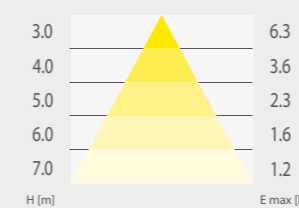

Starlet White II LED SC 200

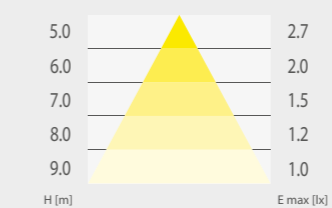

Starlet White II LED SC 300

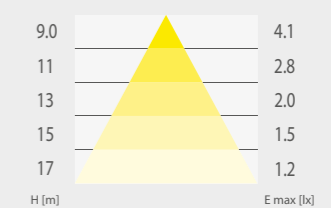

Starlet White II LED SOH 300

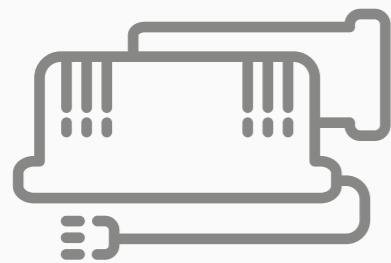

MODUŁY AWARYJNE EMERGENCY MODULES

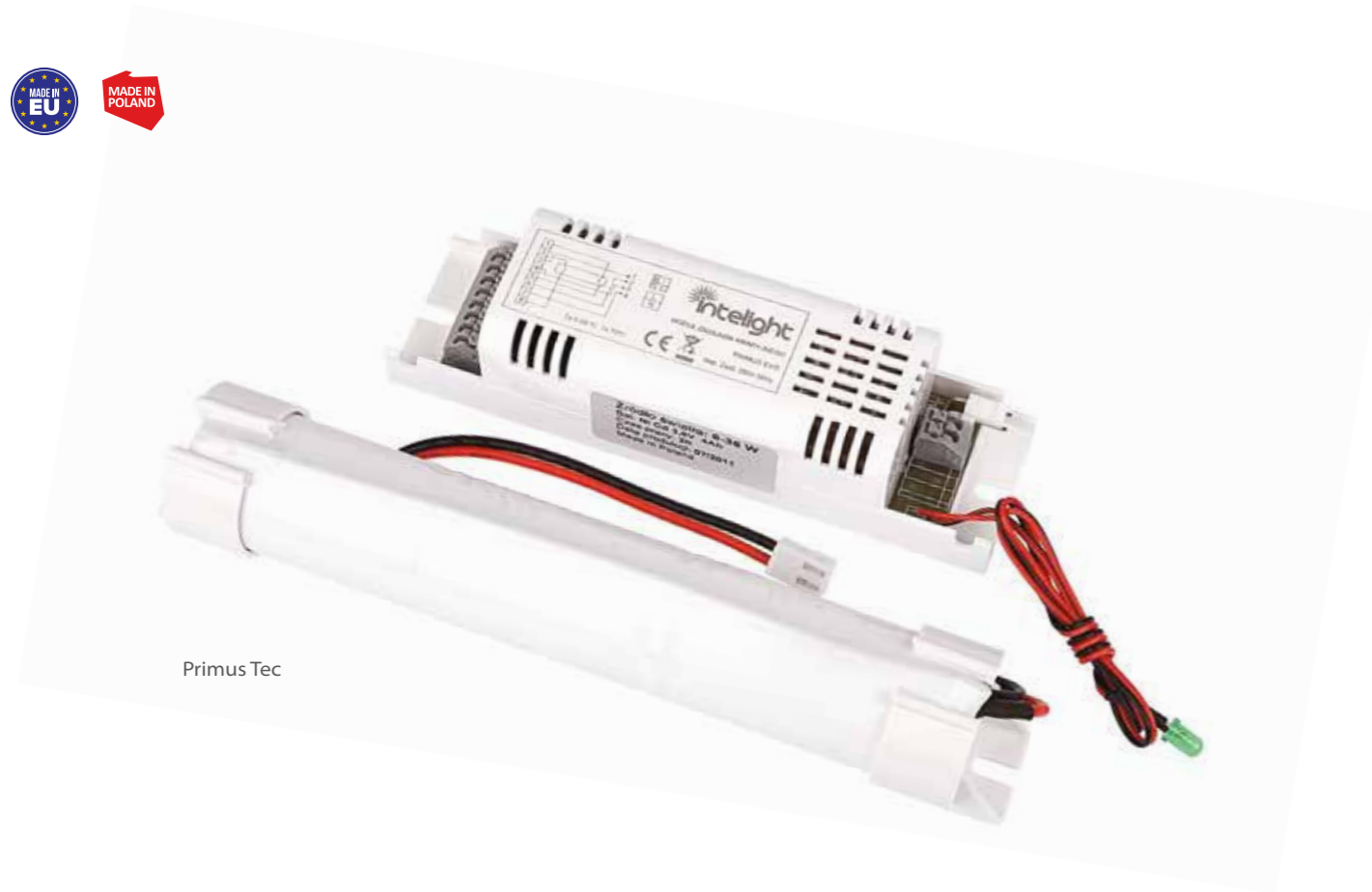

Primus Tec



- Stopień ochrony IP20
- Obudowa modułu z wysokiej jakości poliwęglanu PC klasy V0
- Napięcie zasilania: 230V 50Hz
- Obsługiwane oprawy oświetleniowe: wyposażone w świetlówki 4-pinowe (T8/G13) o mocy 6–58W
- Obsługiwane stateczniki: KVG i EVG
- Funkcje: A (NM) – awaryjna lub SA (M) – sieciowo-awaryjna
- Akumulatory Ni-Cd HT z czasem autonomii: 2h lub 3h, ładowanie: 24h
- Wersja z testem ręcznym na zamówienie
- Montaż: przykręcany w oprawie oświetleniowej lub na zewnątrz
- Do oświetlania dróg i wyjść ewakuacyjnych w budynkach użyteczności publicznej
- Zakres temperatury pracy: t_a 5°C ÷ 50°C
- IP20 protection rating
- The unit enclosure is made of high-quality V0 class PC polycarbonate
- Power supply voltage: 230V 50Hz
- Supported lighting fittings: equipped with 4-pin (T8/G13), 6–58W light tubes
- Supported ballasts: KVG and EVG
- Functions: A (NM) – non-maintained version or SA (M) – maintained version
- Ni-Cd HT batteries with the autonomy time: 2h or 3h
- Version with manual test available on request
- Installation: screw fixed within lighting fitting or externally
- For illuminating evacuation routes and exits in public utility buildings
- Temperature working range: t_a 5°C ÷ 50°C

Pakiety akumulatorów / Battery packs

- Złącze typu V
- Montaż: w uchwytach typu C lub D
- V type connector
- Installation: in C or D type brackets

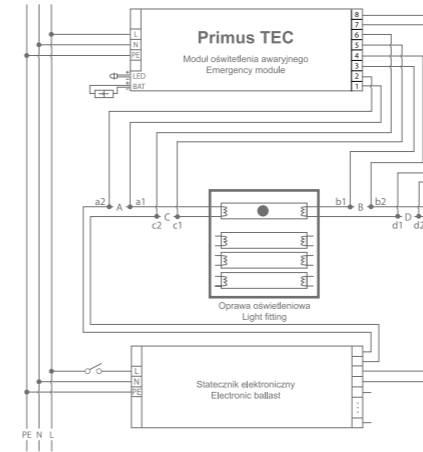

UNIWERSALNY SCHEMAT POŁĄCZEŃ / UNIVERSAL WIRING SCHEME

- Uawaryjniana świetlówka oznaczona jest kropką „•” / Emergency tube is marked with a dot „•”
- Literami A, B, C i D oznaczono miejsca, w których należy przeciąć przewody zasilające uawaryjioną świetlówkę / By A, B, C and D letters there are marked points on wires, where the wires must be cut
- Literami a1, a2, b1, b2, c1, c2, d1 i d2 oznaczono otrzymane w wyniku przecięcia wolne końce przewodów / By a1, a2, b1, b2, c1, c2, d1 and d2 letters with numbers there are marked “free” wires, got after cut
- Należy kolejno przecinać przewody w zaznaczonych miejscach, a następnie otrzymane wolne końce podłączać do wyjść modułu awaryjnego / One must consecutively make cuts as described above and marked on scheme, then connect “free” wires to outputs of and emergency module:
- Przekięcie A: połączyć (a1-1) i (a2-2) / Cut A: connect (a1-1) and (a2-2)
- Przekięcie B: połączyć (b1-3) i (b2-4) / Cut B: connect (b1-3) and (b2-4)
- Przekięcie C: połączyć (c1-5) i (c2-6) / Cut C: connect (c1-5) and (c2-6)
- Przekięcie D: połączyć (d1-7) i (d2-8) / Cut D: connect (d1-7) and (d2-8)

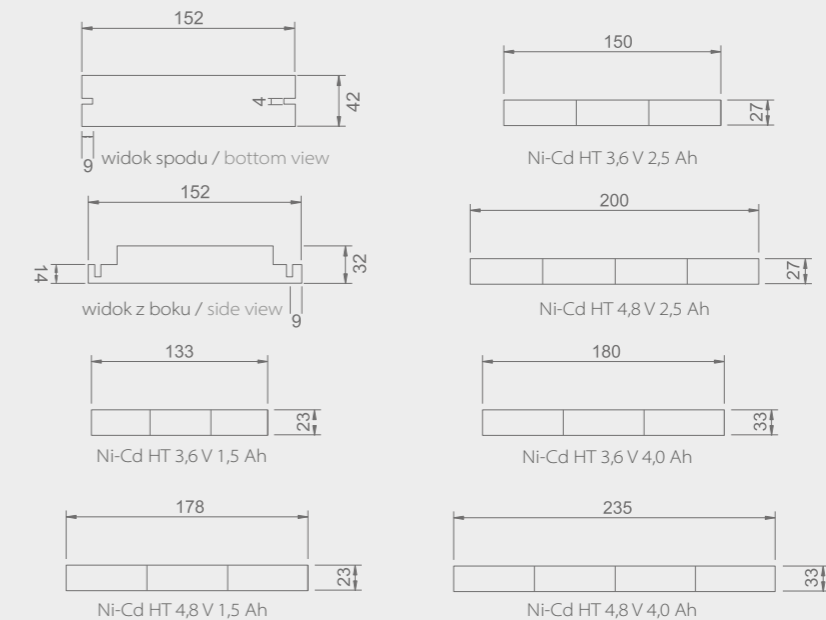

Model / Model	Numer katalogowy* / Catalogue number*	Funkcja / Function	Autonomia** / Autonomy**	Waga z pakietem akumulatorów (kg) / Weight with battery pack (kg)	Opakowanie zbiorcze (szt) / Multi-pack (pcs)
PRIMUS TEC 6-36 W SA/A 1H	97934	SA/A	1h	0,40	40
PRIMUS TEC 6-36 W SA/A 2H	39941	SA/A	2h	0,45	40
PRIMUS TEC 6-36 W SA/A 3H	39942	SA/A	3h	0,55	40
PRIMUS TEC 6-58 W SA/A 1H	97933	SA/A	1h	0,45	40
PRIMUS TEC 6-58 W SA/A 2H	39944	SA/A	2h	0,50	40
PRIMUS TEC 6-58 W SA/A 3H	39945	SA/A	3h	0,60	40

* Numer katalogowy zawiera zestaw: moduł awaryjny i pakiet akumulatorów / The catalogue number contains a kit: an emergency unit and a battery pack
** Modele z czasem autonomii 1 h na zamówienie / Models with 1 h autonomy times available on request

PAKIETY AKUMULATORÓW / BATTERY PACKS

Model / Model	Numer katalogowy / Catalogue number	Typ pakietu / Type of pack	Waga (kg) / Weight (kg)	Opakowanie zbiorcze (szt) / Multi-pack (pcs)
Pakiet akumulatorów Ni-Cd HT 3,6 V 2,5 Ah	40158	C	0,21	40
Pakiet akumulatorów Ni-Cd HT 3,6 V 4,0 Ah	40159	D	0,35	40
Pakiet akumulatorów Ni-Cd HT 4,8 V 2,5 Ah	40161	C	0,28	40
Pakiet akumulatorów Ni-Cd HT 4,8 V 4,0 Ah	40162	D	0,46	40

* Pozostałe pakiety akumulatorów na zamówienie / Other battery packs on request



Primus LED

Primus LED



- › Stopień ochrony IP20
- › Obudowa modułu z wysokiej jakości poliwęglanu PC klasy V0
- › Napięcie zasilania: 230V 50Hz
- › Funkcje: A (NM) – awaryjna lub SA (M) – sieciowo-awaryjna
- › Akumulatory Ni-Cd HT z czasem autonomii: 2h lub 3h; ładowanie: 24h
- › Montaż: przykręcany w oprawie oświetleniowej lub na zewnątrz
- › Do oświetlania dróg i wyjść ewakuacyjnych w budynkach użyteczności publicznej
- › Przeznaczone do montażu w oprawach oświetleniowych wyposażonych w LED-owe źródła światła
- › Przystosowane do współpracy ze świetlówkami LED, zasilanymi ze stałoprądowych zewnętrznych zasilaczy oraz bezpośrednio z sieci 230V AC
- › Zakres temperatury pracy: t_a 5°C ÷ 50°C

- › IP20 protection rating
- › The unit enclosure is made of high-quality V0 class PC polycarbonate
- › Power supply voltage: 230V 50Hz
- › Functions: A (NM) – non-maintained version or SA (M) – maintained version
- › Ni-Cd HT batteries with the autonomy time: 2h or 3h Charging: 24h
- › Installation: screw fixed within a lighting fitting or externally
- › For illuminating evacuation routes and exits in public utility buildings
- › Designed for installation in lighting fittings equipped with LED light sources
- › Adapted to operate with LED tubes powered by external direct current power units and directly from the 230V AC grid
- › Temperature working range: t_a 5°C ÷ 50°C

SCHEMATY PODŁĄCZENIA / CONNECTION DIAGRAMS

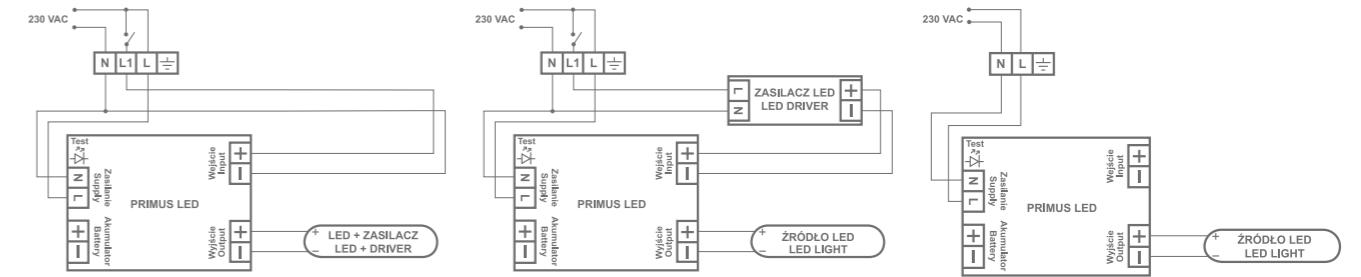

Tryb Sieciowo - Awaryjny (dla zasilacza wbudowanego) dla modeli: D9 i A9 / Maintained operation (for built-in driver) for models: D9 and A9

Tryb Sieciowo - Awaryjny (dla zasilacza zewnętrznego) dla modeli: D1, D2, D3, D4, D6, D8, D8.5 / Maintained operation (for external driver) for models: D1, D2, D3, D4, D6, D8, D8.5

Tryb Awaryjny (bez zasilacza) dla modeli: D1, D2, D3, D4, D6, D8, D8.5 / Non-Maintained operation (without driver) for models: D1, D2, D3, D4, D6, D8, D8.5

Prezentowane powyżej schematy mają charakter poglądowy. W razie jakichkolwiek wątpliwości prosimy o kontakt z wykwalifikowanym elektrykiem bądź z dystrybutorem, u którego zakupiliście państwo urządzenie lub bezpośrednio z naszym działem technicznym. / The connection diagram presented above is of illustrative nature. If in doubt, please contact a qualified electrician or the distributor from whom you purchased the unit, or directly with our technical department.

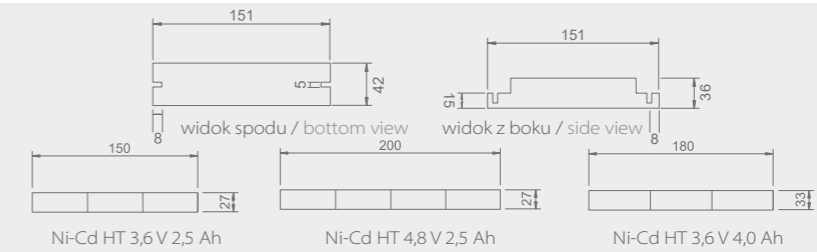

Model / Model	Numer katalogowy / Catalogue number	Autonomia* / Autonomy*	Akumulator / Battery pack	Zastosowanie ** / Applications **
PRIMUS LED D9/A 2H	99946	2h	NiCd 3xC 3,6V 2500mAh	Źródła lub oprawy z zasilaniem 230V AC / LED sources or lamps with 230V AC supply ***
PRIMUS LED D9/A 2H MT	98860	2h	NiCd 3xC 3,6V 2500mAh	Źródła lub oprawy z zasilaniem 230V AC / LED sources or lamps with 230V AC supply ***
PRIMUS LED D9/A 3H MT	98861	3h	NiCd 3xD 3,6V 4000mAh	Źródła lub oprawy z zasilaniem 230V AC / LED sources or lamps with 230V AC supply ***
PRIMUS LED D9/B 2H MT	98882	2h	NiCd 4xC 4,8V 2500mAh	Źródła lub oprawy z zasilaniem 230V AC / LED sources or lamps with 230V AC supply ***
PRIMUS LED D2/A 2H MT	98865	2h	NiCd 3xC 3,6V 2500mAh	Źródła lub oprawy z zasilaniem 12-24V DC / LED sources or lamps with 12-24V DC supply ***
PRIMUS LED D2/A 3H MT	98866	3h	NiCd 3xD 3,6V 4000mAh	Źródła lub oprawy z zasilaniem 12-24V DC / LED sources or lamps with 12-24V DC supply ***
PRIMUS LED D4/A 2H	99937	2h	NiCd 3xC 3,6V 2500mAh	Źródła lub oprawy z zasilaniem 36-48V DC / LED sources or lamps with 36-48V DC supply ***
PRIMUS LED D4/A 2H MT	98867	2h	NiCd 3xC 3,6V 2500mAh	Źródła lub oprawy z zasilaniem 36-48V DC / LED sources or lamps with 36-48V DC supply ***
PRIMUS LED D4/A 3H MT	98868	3h	NiCd 3xD 3,6V 4000mAh	Źródła lub oprawy z zasilaniem 36-48V DC / LED sources or lamps with 36-48V DC supply ***
PRIMUS LED D6/A MT 2h	98869	2h	NiCd 3xC 3,6V 2500mAh	Źródła lub oprawy z zasilaniem 48-75V DC / LED sources or lamps with 48-75V DC supply ***
PRIMUS LED D6/A MT 3h	98870	3h	NiCd 3xD 3,6V 4000mAh	Źródła lub oprawy z zasilaniem 48-75V DC / LED sources or lamps with 48-75V DC supply **
PRIMUS LED D8/A 2H MT	98856	2h	NiCd 3xC 3,6V 2500mAh	Źródła lub oprawy z zasilaniem 75-100V DC / LED sources or lamps with 75-100V DC supply ***
PRIMUS LED D8/A 3H MT	98857	3h	NiCd 3xD 3,6V 4000mAh	Źródła lub oprawy z zasilaniem 75-100V DC / LED sources or lamps with 75-100V DC supply ***
PRIMUS LED D8.5/F 2H MT	93299	2h	NiCd 3xC 3,6V 2500mAh	Źródła lub oprawy z zasilaniem 100-150V DC / LED sources or lamps with 100-150V DC supply
PRIMUS LED D8.5/F 3H MT	93263	3h	NiCd 3xD 3,6V 4000mAh	Źródła lub oprawy z zasilaniem 100-150V DC / LED sources or lamps with 100-150V DC supply
PRIMUS LED A9/A 2H MT	98858	2h	NiCd 3xC 3,6V 2500mAh	Źródła lub oprawy z zasilaniem 230V AC / LED sources or lamps with 230V AC supply
PRIMUS LED A9/A 3H MT	98859	3h	NiCd 3xD 3,6V 4000mAh	Źródła lub oprawy z zasilaniem 230V AC / LED sources or lamps with 230V AC supply

* Dostępne są również czasy autonomii 1h oraz 3h / 1h and 3h autonomy times are also available on request
 ** Poniższe informacje są ogólne, dokładny dobór może nastąpić po konsultacji z działem handlowym / The information given below is general, please consult the commercial department to make a choice
 *** Zależnie od technicznej możliwości podłączenia modułu przed lub za zasilaczem LED / Depending on possibility to connect an emergency module either on input or output of a LED driver



Primus LED HP

Primus LED HP



- › Stopień ochrony IP20
 - › Obudowa modułu z wysokiej jakości poliwęglanu PC klasy V0
 - › Napięcie zasilania: 230V 50Hz
 - › Automatyczne dopasowanie do napięcia źródła LED
 - › Zakres napięć źródła LED: 20V DC - 80V DC
 - › Wysoka moc wyjściowa: 3W, 6W, 9W i 12W
 - › Funkcje: A (NM) – awaryjna lub SA (M) – sieciowo-awaryjna
 - › Funkcje testowania: AT - auto test jako standard
 - › Nowoczesne i wydajne akumulatory LiFePO4
 - › Szeroki zakres dostępnych autonomii: 2h, 3h i 8h
 - › Montaż: przykręcany w oprawie oświetleniowej lub na zewnątrz
 - › Do oświetlania dróg i wyjść ewakuacyjnych w budynkach użyteczności publicznej
 - › Przeznaczone do montażu w oprawach oświetleniowych wyposażonych w LED-owe źródła światła
 - › Zakres temperatury pracy: t_3 5°C ÷ 50°C
- › IP20 protection rating
 - › The unit enclosure is made of high-quality V0 class PC polycarbonate
 - › Power supply voltage: 230V 50Hz
 - › Automatic adjustment to an LED light source voltage
 - › LED light source voltage range: 20V DC - 80V DC
 - › High output power in an emergency mode: 3W, 6W, 9W and 12W
 - › Functions: A (NM) – non-maintained version or SA (M) – maintained version
 - › Testing functions: AT - auto test as standard
 - › Modern and efficient LiFePO4 battery packs
 - › Wide range of available autonomies: 2h, 3h and 8h
 - › Installation: screw fixed within a lighting fitting or externally
 - › For illuminating evacuation routes and exits in public utility buildings
 - › Designed for installation in lighting fittings equipped with LED light sources
 - › Temperature working range: t_3 5°C ÷ 50°C

SCHEMATY PODŁĄCZENIA / CONNECTION DIAGRAMS

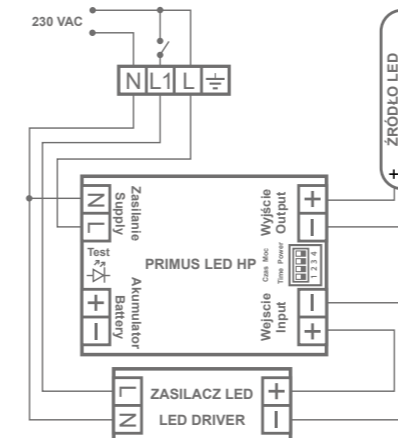

Tryb Sieciowo-Awaryjny / Maintained operation

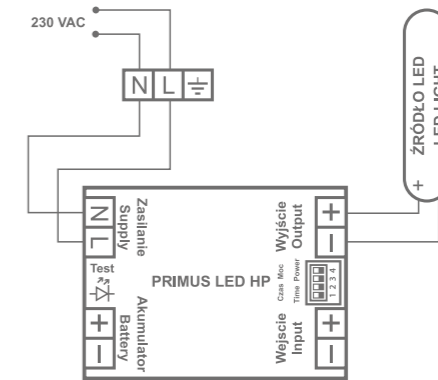

Tryb Awaryjny / Non-Maintained operation

Prezentowane powyżej schematy mają charakter poglądowy. W razie jakichkolwiek wątpliwości prosimy o kontakt z wykwalifikowanym elektrykiem bądź z dystrybutorem, u którego zakupiliście państwo urządzenie lub bezpośrednio z naszym działem technicznym. / The connection diagram presented above is of illustrative nature. If in doubt, please contact a qualified electrician or the distributor from whom you purchased the unit, or directly with our technical department.

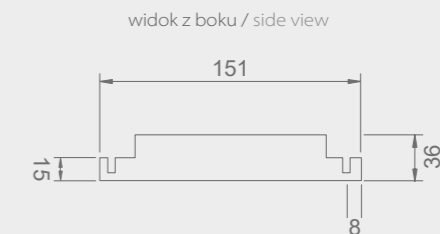
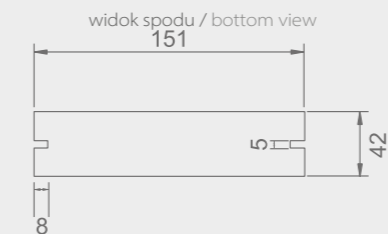

Model zestawu awaryjnego / Emergency kit model	Numer katalogowy* / Catalogue number*	Moc zestawu** / Kit power**	Funkcja / Function	Autonomia** / Autonomy**	Test / Test	Zakres napięć źródła LED / LED light source voltage range	Akumulator w zestawie / Battery pack included
Primus LED HP 3W M/NM 2H AT	93315	3W	SA/A (M/NM)	2h	AT	20VDC - 80VDC	LiFePO4 12,8V / 1000mh
Primus LED HP 3W M/NM 3H AT	93314	3W	SA/A (M/NM)	3h	AT	20VDC - 80VDC	LiFePO4 12,8V / 1600mh
Primus LED HP 3W M/NM 8H AT	93313	3W	SA/A (M/NM)	8h	AT	20VDC - 80VDC	LiFePO4 12,8V / 3000mh
Primus LED HP 6W M/NM 2H AT	93311	6W	SA/A (M/NM)	2h	AT	20VDC - 80VDC	LiFePO4 12,8V / 1600mh
Primus LED HP 6W M/NM 3H AT	93310	6W	SA/A (M/NM)	3h	AT	20VDC - 80VDC	LiFePO4 12,8V / 3000mh
Primus LED HP 9W M/NM 2H AT	93307	9W	SA/A (M/NM)	2h	AT	20VDC - 80VDC	LiFePO4 12,8V / 3000mh
Primus LED HP 9W M/NM 3H AT	93306	9W	SA/A (M/NM)	3h	AT	20VDC - 80VDC	LiFePO4 12,8V / 3000mh
Primus LED HP 12W M/NM 2H AT	93303	12W	SA/A (M/NM)	2h	AT	20VDC - 80VDC	LiFePO4 12,8V / 3000mh
Primus LED HP 12W M/NM 3H AT	93302	12W	SA/A (M/NM)	3h	AT	20VDC - 80VDC	LiFePO4 12,8V / 4000mh

* Numer katalogowy zawiera zestaw: moduł awaryjny i pakiet akumulatorów / Catalogue number contains: an emergency module and a battery pack
** Modele 8h dla mocy 6W, 9W i 12W - dostępne na specjalne życzenie / 8h models for 6W, 9W and 12W powers - available on special request

Powyższe dane mogą ulec zmianie / The above data is subject to change



**OPRAWY
PRZEMYSŁOWE**
INDUSTRIAL
LUMINAIRES



Wars LED Panel



- ▶ Stopień ochrony IP65
- ▶ Korpus i klosz wykonany z wysokiej jakości poliwęglanu (PC)
- ▶ Zatrzaski klosza z poliwęglanu (PC), opcjonalnie ze stali nierdzewnej (INOX)
- ▶ Napięcie zasilania: 230VAC (wersje MT, AT i CT) lub 230VAC/220VDC (wersja CB)
- ▶ Źródło światła: nowoczesne panele LED
- ▶ Wersje wielkości obudowy: 6 (3 długości: 60, 120 i 150 / 2 szerokości: 1x i 2x)
- ▶ Zakres dostępnych mocy opraw: od 19W do 60W
- ▶ Dostępne wykonania: oświetlenie podstawowe, awaryjne i awaryjne LT do niskich temperatur (do -25°C)
- ▶ Dostępne moce świecenia awaryjnego: od 2W do 12W
- ▶ Tryby awaryjne: A – awaryjny lub SA – sieciowo-awaryjny
- ▶ Czasy autonomii: 2h, 3h
- ▶ Opcje testowania: MT – test ręczny, AT – test automatyczny, CT – test centralny (Wells) lub CB – wykonanie do baterii centralnej
- ▶ Akumulatory do wykonania awaryjnych: NiCd lub LiFePO4 (zależnie od wersji)
- ▶ Montaż: sufitowy lub na zwieszakach – regulowany
- ▶ Do oświetlania hal przemysłowych, magazynów, tuneli, piwnic, garaży, itp. (oświetlenie podstawowe) oraz do oświetlania stref otwartych, dróg i wyjść ewakuacyjnych (oświetlenie awaryjne) w budynkach użyteczności publicznej
- ▶ Temperatura barwowa: 4000K
- ▶ Współczynnik oddawania barw: Ra>=80
- ▶ Zakres temperatur pracy: $t_a = -25^{\circ}\text{C} \div +40^{\circ}\text{C}$ (oświetlenie podstawowe), $t_a = +10^{\circ}\text{C} \div +30^{\circ}\text{C}$ (oświetlenie awaryjne) lub $t_a = -25^{\circ}\text{C} \div +30^{\circ}\text{C}$ (oświetlenie awaryjne LT do niskich temperatur)

- ▶ IP65 protection rating of a housing
- ▶ Housing's base and diffuser made of high quality polycarbonate (PC)
- ▶ Diffuser's clips made of polycarbonate (PC), optionally of stainless steel (INOX)
- ▶ Power supply voltage: 230VAC (MT, AT and CT versions) or 230VAC/220VDC (CB version)
- ▶ Light source: modern LED panels
- ▶ Housing's sizes versions: 6 (3 lengths: 60, 120 and 150 / 2 widths: 1x and 2x)
- ▶ Luminaires' available power's range: from 19W to 60W
- ▶ Available models: standard, emergency and LT low temperature (up to -25°C) emergency lighting
- ▶ Available emergency powers: from 2W to 12W
- ▶ Emergency modes: A – Non-Maintained or SA – Maintained
- ▶ Autonomy times: 2h, 3h
- ▶ Testing options: MT – manual test, AT – auto test, CT – central test (Wells) or CB – central battery version
- ▶ Batteries for emergency versions: NiCd or LiFePO4 (depending on version)
- ▶ Ceiling installation or pendant type installation – adjustable
- ▶ For illuminating industrial halls, warehouses, tunnels, basements, garages, etc. (standard lighting) and open spaces, evacuation ways and exits (emergency lighting) in public utility buildings
- ▶ Colour temperature: 4000K
- ▶ Colour rendering index: Ra>=80
- ▶ Temperature working range: $t_a = -25^{\circ}\text{C} \div +40^{\circ}\text{C}$ (standard lighting), $t_a = +10^{\circ}\text{C} \div +30^{\circ}\text{C}$ (emergency lighting) or $t_a = -25^{\circ}\text{C} \div +30^{\circ}\text{C}$ (LT low temperature emergency lighting)

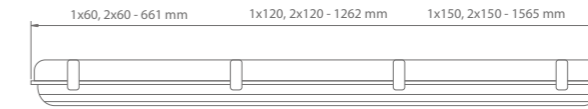
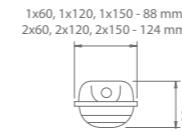

MODELE STANDARDOWE / STANDARD MODELS

Model / Model	Numer katalogowy / Catalogue number	Moc całkowita / Total power	Strumień świetlny / Luminous flux	Temperatura barwowa / Colour temperature
WARS LED PANEL 1X60 4000K	93101	19W	2100 lm	4000K
WARS LED PANEL 2X60 4000K	93102	24W	2700 lm	4000K
WARS LED PANEL 1X120 4000K	93103	39W	3200 lm	4000K
WARS LED PANEL 2X120 4000K	93104	49W	4500 lm	4000K
WARS LED PANEL 1X150 4000K	93105	49W	4900 lm	4000K
WARS LED PANEL 2X150 4000K	93106	60W	5800 lm	4000K

MODELE AWARYJNE Z TESTEM MANUALNYM / EMERGENCY MODELS WITH MANUAL TEST



Model / Model	Numer katalogowy / Catalogue number	Moc całkowita / Total power	Moc awaryjna / Emergency power	Strumień świetlny sieciowy / Mains luminous flux	Strumień świetlny awaryjny / Emergency luminous flux	Tryb / Mode	Autonomia / Autonomy	Akumulator / Battery Pack	Test / Test
WARS LED PANEL 1X60 SA 2H MT 4000K	93119	22W	2W	2100 lm	285 lm	SA (M)	2h	NiCd 3,6V 2500mAh	MT
WARS LED PANEL 2X60 SA 2H MT 4000K	93120	27W	2W	2700 lm	275 lm	SA (M)	2h	NiCd 3,6V 2500mAh	MT
WARS LED PANEL 2X60 SA 3H MT 4000K	93126	27W	2W	2700 lm	275 lm	SA (M)	3h	NiCd 3,6V 4000mAh	MT
WARS LED PANEL 1X120 SA 2H MT 4000K	93121	42W	2W	3200 lm	255 lm	SA (M)	2h	NiCd 3,6V 2500mAh	MT
WARS LED PANEL 1X120 SA 3H MT 4000K	93127	42W	2W	3200 lm	255 lm	SA (M)	3h	NiCd 3,6V 4000mAh	MT
WARS LED PANEL 2X120 SA 2H MT 4000K	93122	52W	2W	4500 lm	255 lm	SA (M)	2h	NiCd 3,6V 2500mAh	MT
WARS LED PANEL 2X120 SA 3H MT 4000K	93128	52W	2W	4500 lm	255 lm	SA (M)	3h	NiCd 3,6V 4000mAh	MT
WARS LED PANEL 1X150 SA 2H MT 4000K	93123	52W	2W	4900 lm	245 lm	SA (M)	2h	NiCd 3,6V 2500mAh	MT
WARS LED PANEL 1X150 SA 3H MT 4000K	93129	52W	2W	4900 lm	245 lm	SA (M)	3h	NiCd 3,6V 4000mAh	MT
WARS LED PANEL 2X150 SA 2H MT 4000K	93124	63W	2W	5800 lm	230 lm	SA (M)	2h	NiCd 3,6V 2500mAh	MT
WARS LED PANEL 2X150 SA 3H MT 4000K	93130	63W	2W	5800 lm	230 lm	SA (M)	3h	NiCd 3,6V 4000mAh	MT

MODELE AWARYJNE Z TESTEM AUTOMATYCZNYM / EMERGENCY MODELS WITH AUTO TEST



Model / Model	Numer katalogowy / Catalogue number	Moc całkowita / Total power	Moc awaryjna / Emergency power	Strumień świetlny sieciowy / Mains luminous flux	Strumień świetlny awaryjny / Emergency luminous flux	Tryb / Mode	Autonomia / Autonomy	Akumulator / Battery Pack	Test / Test
WARS LED PANEL 1X60 SA-3W 2H AT 4000K	93137	22W	3W	2100 lm	490 lm	SA (M)	2h	LiFePO4 12,8V 1000mAh	AT
WARS LED PANEL 1X60 SA-3W 3H AT 4000K	93143	22W	3W	2100 lm	490 lm	SA (M)	3h	LiFePO4 12,8V 1600mAh	AT
WARS LED PANEL 2X60 SA-6W 2H AT 4000K	93138	27W	6W	2700 lm	900 lm	SA (M)	2h	LiFePO4 12,8V 1600mAh	AT
WARS LED PANEL 1X120 SA-6W 2H AT 4000K	93139	42W	6W	3200 lm	790 lm	SA (M)	2h	LiFePO4 12,8V 1600mAh	AT
WARS LED PANEL 1X120 SA-6W 3H AT 4000K	93145	42W	6W	3200 lm	790 lm	SA (M)	3h	LiFePO4 12,8V 3000mAh	AT
WARS LED PANEL 2X120 SA-9W 2H AT 4000K	93140	52W	9W	4500 lm	1195 lm	SA (M)	2h	LiFePO4 12,8V 3000mAh	AT
WARS LED PANEL 2X120 SA-9W 3H AT 4000K	93146	52W	9W	4500 lm	1195 lm	SA (M)	3h	LiFePO4 12,8V 3000mAh	AT
WARS LED PANEL 1X150 SA-9W 2H AT 4000K	93141	52W	9W	4900 lm	1290 lm	SA (M)	2h	LiFePO4 12,8V 3000mAh	AT
WARS LED PANEL 1X150 SA-9W 3H AT 4000K	93147	52W	9W	4900 lm	1290 lm	SA (M)	3h	LiFePO4 12,8V 3000mAh	AT
WARS LED PANEL 2X150 SA-12W 2H AT 4000K	93142	63W	12W	5800 lm	1575 lm	SA (M)	2h	LiFePO4 12,8V 3000mAh	AT
WARS LED PANEL 2X150 SA-12W 3H AT 4000K	93148	63W	12W	5800 lm	1575 lm	SA (M)	3h	LiFePO4 12,8V 4000mAh	AT

A (NM) - tryb awaryjny / non-maintained mode
SA - tryb sieciowo-awaryjny / maintained mode

MT - tryb ręczny / manual test
AT - tryb automatyczny / autotest

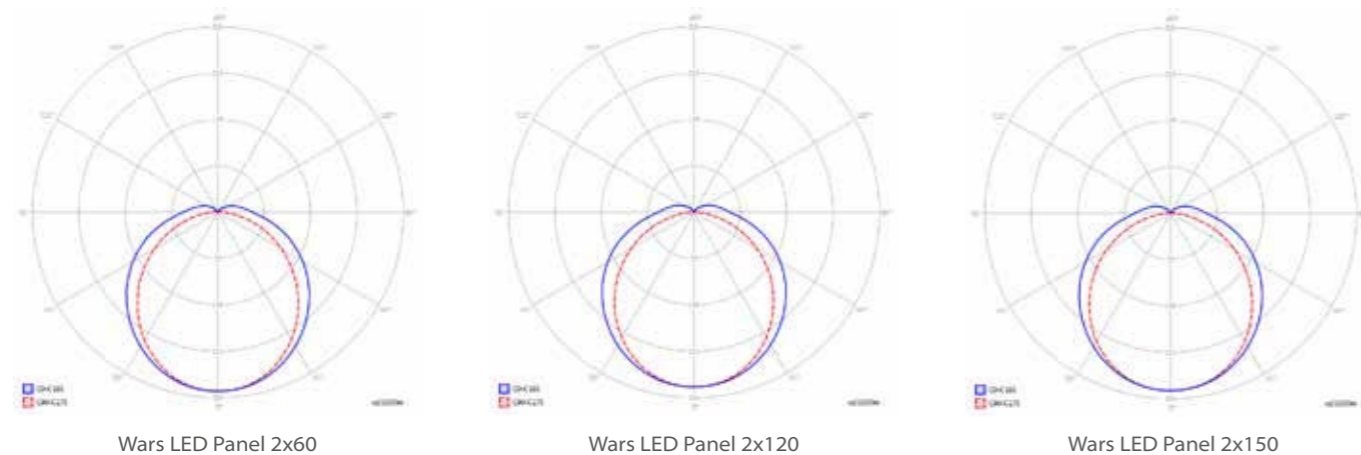

Wars LED Panel 2x60

Wars LED Panel 2x120

Wars LED Panel 2x150



MODELE AWARYJNE PRZYSTOSOWANE DO NISKICH TEMPERATUR /
EMERGENCY MODELS ADEPTED FOR LOW TEMPERATURES



Model / Model	Numer katalogowy / Catalogue number	Moc całkowita / Total power	Moc awaryjna / Emergency power	Strumień świetlny sieciowy / Mains luminous flux	Strumień świetlny awaryjny / Emergency luminous flux	Tryb / Mode	Autonomia / Autonomy	Akumulator / Battery Pack	Test / Test
WARS LED PANEL 2X60 SA 3H MT 4000K LT	93185	41W	2W	2700 lm	275 lm	SA (M)	3h	NiCd 3,6V 4000mAh	MT
WARS LED PANEL 2X120 SA 3H MT 4000K LT	93182	66W	2W	4500 lm	255 lm	SA (M)	3h	NiCd 3,6V 4000mAh	MT
WARS LED PANEL 2X150 SA 3H MT 4000K LT	93186	77W	2W	5800 lm	230 lm	SA (M)	3h	NiCd 3,6V 4000mAh	MT

SA (M) - tryb sieciowo-awaryjny / maintained mode

MT - test ręczny / manual test

LT - Model przystosowany do niskich temperatur (do t_a -25°C) / Model adapted for low temperatures (up to t_a -25°C)

MODELE DO BATERII CENTRALNEJ / MODELS FOR CENTRAL BATTERY

Model / Model	Numer katalogowy / Catalogue number	Moc całkowita / Total power	Strumień świetlny / Luminous flux	Temperatura barwowa / Colour temperature
WARS LED PANEL 1X60 CB 4000K	93107	19W	2100 lm	4000K
WARS LED PANEL 2X60 CB 4000K	93108	24W	2700 lm	4000K
WARS LED PANEL 1X120 CB 4000K	93109	39W	3200 lm	4000K
WARS LED PANEL 2X120 CB 4000K	93110	49W	4500 lm	4000K
WARS LED PANEL 1X150 CB 4000K	93111	49W	4900 lm	4000K
WARS LED PANEL 2X150 CB 4000K	93112	60W	5800 lm	4000K

TABELE ODSTEPÓW DLA PŁASKICH DRÓG EWAKUACYJNYCH I PRZESTRZENI OTWARTYCH / SPACING TABLES FOR FLAT EVACUATION ROUTES AND OPEN SPACES

WARS LED PANEL 2x60 MT

Wysokość montażu (m) / Installation height (m)	3,7	9,5	8,7	3,4
2,5	3,7	9,5	8,7	3,4
3	3,8	10,1	9,2	3,5
4	3,8	10,8	10,0	3,6

WARS LED PANEL 2x120 MT

Wysokość montażu (m) / Installation height (m)	3,5	9,4	8,5	3,3
2,5	3,5	9,4	8,5	3,3
3	3,7	9,9	9,1	3,4
4	3,7	10,5	9,8	3,4

WARS LED PANEL 2x150 MT

Wysokość montażu (m) / Installation height (m)	3,4	9,0	8,4	3,3
2,5	3,4	9,0	8,4	3,3
3	3,4	9,4	8,8	3,3
4	3,4	10,0	9,5	3,3

WARS LED PANEL 2x60 SA-6W AT

Wysokość montażu (m) / Installation height (m)	5,6	12,1	10,7	4,9
2,5	5,6	12,1	10,7	4,9
3	5,8	14,5	12,8	5,2
4	6,4	16,6	14,9	5,9

WARS LED PANEL 2x120 SA-9W AT

Wysokość montażu (m) / Installation height (m)	6,1	12,4	10,9	5,3
2,5	6,1	12,4	10,9	5,3
3	6,4	14,8	13,0	5,8
4	7,2	18,4	16,3	6,4

WARS LED PANEL 2x150 SA-12W AT

Wysokość montażu (m) / Installation height (m)	6,1	12,3	10,9	5,6
2,5	6,1	12,3	10,9	5,6
3	7,0	15,3	13,3	6,1
4	7,8	19,4	17,1	6,9

WYKRESY STOJKOWE / CONE DIAGRAMS



Wars LED Panel 2x60 MT*

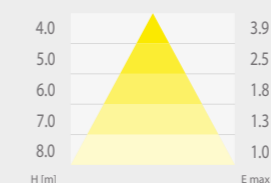

Wars LED Panel 2x120 MT*

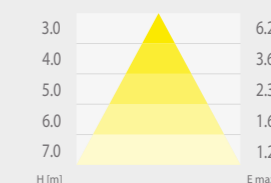

Wars LED Panel 2x150 MT*



Wars LED Panel 2x60 SA-6W AT*



Wars LED Panel 2x120 SA-9W AT*

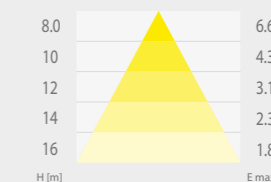

Wars LED Panel 2x150 SA-12W AT*

* Wykresy dla wersji awaryjnych / Diagrams for emergency versions

AKCESORIA / ACCESSORIES

Wykonanie produktu / Product version	Numer katalogowy / Catalogue number
Zestaw do montażu zwieszanego / Suspended mounting kit	93075
Zestaw klipsów INOX do Wars Led Panel 6 sztuk * / Set of INOX clips for Wars Led Panel 6 pcs. *	93231
Zestaw klipsów INOX do Wars Led Panel 10 sztuk ** / Set of INOX clips for Wars Led Panel 10 pcs. **	93232

* użycie: 1 zestaw do opraw 1x60 lub 2x60; 2 zestawy do opraw 1x150 lub 2x150 / use: 1 set for 1x60 or 2x60 luminaires; 2 sets for 1x150 or 2x150 luminaires

** użycie: 1 zestaw do opraw 1x120 lub 2x120 / use: 1 set for 1x120 or 2x120 luminaires



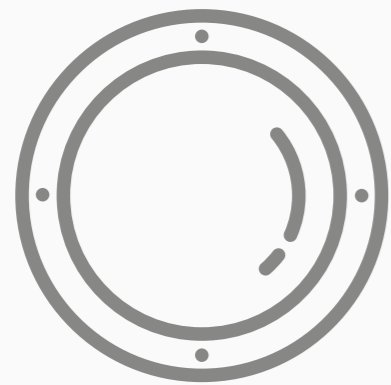

PLAFONIERY

PLAFONDS



Cosmic Quad LED

Cosmic LED

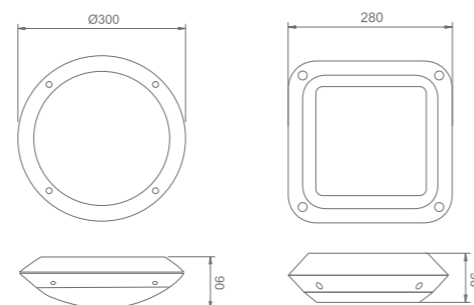

Cosmic LED

Cosmic Quad LED

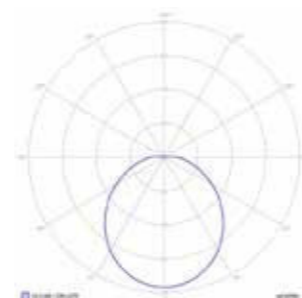

Cosmic LED 12W

Cosmic LED



- ▶ Najnowsze serie plafonier wyposażone w źródła światła LED
- ▶ Zastosowana technologia pozwala na bardzo dużą oszczędność energii w stosunku do dotychczasowych źródeł LED przy utrzymaniu wysokiej jakości światła
- ▶ Bardzo wysoka efektywność świetlna diod
- ▶ Klasa szczelności IP66
- ▶ Montaż natynkowy, sufitowy lub ścienny
- ▶ Klosz i podstawa wykonane z poliwęglanu
- ▶ Napięcie zasilania: 230V 50Hz
- ▶ Źródło światła: LED 9W, 12W
- ▶ Nominalna żywotność: 50 000h
- ▶ Typowe miejsca: korytarze, klatki schodowe, miejsca o podwyższonej wilgotności lub na zewnątrz budynków
- ▶ Współczynnik oddawania barw: Ra>=80
- ▶ Zakres temperatury pracy: t_a 10°C ÷ 50°C

- ▶ Latest series of plafonds equipped with LED light sources
- ▶ The technology employed allows very high energy savings as compared to the conventional LED sources while maintaining high quality of light
- ▶ Very high LED luminous efficacy
- ▶ IP66 protection rating
- ▶ Surface-mount installation, on ceiling or wall
- ▶ Lampshade and base made of polycarbonate
- ▶ Power supply voltage: 230V 50Hz
- ▶ Light source: LED 9W, 12W
- ▶ Rated lifetime: 50,000h
- ▶ Typical places: corridors, staircases, places with higher humidity or outdoors
- ▶ CRI index: Ra>=80
- ▶ Temperature working range: t_a 10°C ÷ 50°C

MODELE AWARYJNE Z CERTYFIKATEM CNBOP / EMERGENCY MODELS WITH CNBOP CERTIFICATE

Model / Model	Numer katalogowy / Catalogue number	Strumień świetlny / Luminous flux	Źródło światła / Light source	Funkcja / Function	Autonomia / Autonomy	Temperatura barwowa* / Colour temperature*	Waga (kg) / Weight (kg)
Cosmic LED 9W 2H SA	98520	890 lm	LED 9W	SA (M)	2h	4000K	1,3
Cosmic LED 9W 2H SA MD **	96715	890 lm	LED 9W	SA (M)	2h	4000K	1,4
Cosmic Quad LED 9W 2H SA	99860	730 lm	LED 9W	SA (M)	2h	4000K	1,3
Cosmic Quad LED 9W 2H SA MD **	97760	730 lm	LED 9W	SA (M)	2h	4000K	1,4
Cosmic LED 12W 2H SA	97761	1340 lm	LED 12W	SA (M)	2h	4000K	1,1
Cosmic LED 12W 2H SA MD **	98023	1340 lm	LED 12W	SA (M)	2h	4000K	1,4
Cosmic Quad LED 12W SA 2H	97731	1150 lm	LED 12W	SA (M)	2h	4000K	1,1
Cosmic Quad LED 12W SA 2H MD **	97729	1150 lm	LED 12W	SA (M)	2h	4000K	1,4

MODELE STANDARDOWE / STANDARD MODELS

Model / Model	Numer katalogowy / Catalogue number	Strumień świetlny / Luminous flux	Źródło światła / Light source	Temperatura barwowa* / Colour temperature*	Waga (kg) / Weight (kg)
Cosmic LED 9W	98323	890 lm	LED 9W	4000K	0,9
Cosmic LED 12W	97848	1340 lm	LED 12W	4000K	0,9
Cosmic Quad LED 9W	99859	730 lm	LED 9W	4000K	0,9
Cosmic Quad LED 12W	97735	1150 lm	LED 12W	4000K	0,9

MODELE STANDARDOWE Z CZUJNIKIEM RUCHU / STANDARD MODELS WITH MOVEMENT DETECTOR

Model** / Model**	Numer katalogowy / Catalogue number	Strumień świetlny / Luminous flux	Źródło światła / Light source	Temperatura barwowa* / Colour temperature*	Waga (kg) / Weight (kg)
Cosmic LED 9W MD	96716	890 lm	LED 9W	4000K	1,1
Cosmic LED 12W MD	97847	1340 lm	LED 12W	4000K	1,1
Cosmic Quad LED 9W MD	97759	730 lm	LED 12W	4000K	1,0
Cosmic Quad LED 12W MD	97733	1150 lm	LED 12W	4000K	1,1

* Inne temperatury barwowe (3000K lub 5000K) na życzenie / Other colour temperatures (3000K or 5000K) on request
** Model z czujnikiem ruchu / Model with movement sensor

TABELA ODSTĘPÓW DLA PŁASKICH DRÓG EWAKUACYJNYCH / SPACING TABLE FOR FLAT EVACUATION ROUTES

COSMIC 9W

Wysokość montażu (m) / Installation height (m)	1	2	3	4
2,5	2,6	7,1	7,1	2,6
3	2,7	7,5	7,5	2,7
4	2,5	7,8	7,8	2,5

COSMIC 12W

Wysokość montażu (m) / Installation height (m)	1	2	3	4
2,5	3,5	9,1	9,1	3,5
3	3,7	9,6	9,6	3,7
4	3,8	10,5	10,5	3,8

COSMIC QUAD

Wysokość montażu (m) / Installation height (m)	1	2	3	4
2,5	2,0	5,8	5,8	2,0
3	1,8	5,9	5,9	1,8
4	1,0	5,6	5,6	1,0



* Wykresy dla wersji awaryjnych / Charts for emergency versions

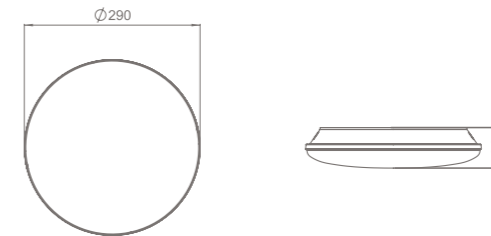

Milo LED



- ▶ Najnowsze serie plafonier wyposażonych w źródła światła LED
- ▶ Zastosowana technologia pozwala na bardzo dużą oszczędność energii w stosunku do dotychczasowych źródeł LED przy utrzymaniu wysokiej jakości światła
- ▶ Bardzo wysoka efektywność świetlna
- ▶ Klasa szczelności IP65
- ▶ Montaż natynkowy, sufitowy lub ścienny
- ▶ Klosz i podstawa wykonane z poliwęglanu (PC)
- ▶ Napięcie zasilania: 230V 50Hz
- ▶ Źródło światła: LED 10W
- ▶ Nominalna żywotność: 50 000h
- ▶ Dostępne wersje do oświetlania podstawowego lub awaryjnego
- ▶ Wysoki awaryjny strumień świetlny
- ▶ Dostępne wersje LT do niskich temperatur
- ▶ Wszystkie oprawy mogą być wykonane bez czujnika ruchu, z czujnikiem ruchu on-off lub z czujnikiem ściemnianym
- ▶ Współczynnik oddawania barw: Ra>=80
- ▶ Zakres temperatury pracy: t_a 10°C ÷ 40°C lub -25°C ÷ +40°C

- ▶ Latest series of plafonds equipped with LED light sources
- ▶ The technology employed allows very high energy savings as compared to the conventional LED sources while maintaining high quality of light
- ▶ Very high luminous efficacy
- ▶ IP65 protection rating
- ▶ Surface-mount installation, on ceiling or wall
- ▶ Lampshade and base made of polycarbonate (PC)
- ▶ Power supply voltage: 230V 50Hz
- ▶ Light source: LED 10W
- ▶ Rated lifetime: 50,000h
- ▶ General lighting and emergency lighting versions available
- ▶ High emergency luminous flux
- ▶ LT versions for low temperatures available
- ▶ All luminaires can be made without movement detector, with on-off detector or with dimmable detector
- ▶ CRI index: Ra>=80
- ▶ Temperature working range: t_a 10°C ÷ 40°C or -25°C ÷ +40°C

MODELE AWARYJNE / EMERGENCY MODELS

Model / Model	Numer katalogowy / Catalogue number	Strumień świetlny / Luminous flux	Moc / Power	Funkcja / Function	Autonomia / Autonomy	Temperatura barwowa* / Colour temperature*	Czujnik ruchu (MD)** / Movement detector (MD)**	Temperatura pracy / Working temperature	Akumulator / Battery Pack
MILO LED SA 3H MT 4000K	92783	450 lm	16W	SA (M)	3h	4000K	-	10°C ÷ 40°C	LiFePO4 6,4V 3000mAh
MILO LED SA 3H MT 4000K MD	92782	450 lm	17W	SA (M)	3h	4000K	ON-OFF	10°C ÷ 40°C	LiFePO4 6,4V 3000mAh
MILO LED SA 3H MT 4000K MDD	92781	450 lm	16W	SA (M)	3h	4000K	DIM	10°C ÷ 40°C	LiFePO4 6,4V 3000mAh
MILO LED SA 2H MT 4000K LT	92762	450 lm	24W	SA (M)	2h	4000K	-	-25°C ÷ 40°C	LiFePO4 6,4V 3000mAh
MILO LED SA 2H MT 4000K MD LT	92761	450 lm	25W	SA (M)	2h	4000K	ON-OFF	-25°C ÷ 40°C	LiFePO4 6,4V 3000mAh
MILO LED SA 2H MT 4000K MDD LT	92760	450 lm	24W	SA (M)	2h	4000K	DIM	-25°C ÷ 40°C	LiFePO4 6,4V 3000mAh
MILO LED SA 3H MT 3000K	92792	450 lm	16W	SA (M)	3h	3000K	-	10°C ÷ 40°C	LiFePO4 6,4V 3000mAh
MILO LED SA 3H MT 3000K MD	92791	450 lm	17W	SA (M)	3h	3000K	ON-OFF	10°C ÷ 40°C	LiFePO4 6,4V 3000mAh
MILO LED SA 3H MT 3000K MDD	92790	450 lm	16W	SA (M)	3h	3000K	DIM	10°C ÷ 40°C	LiFePO4 6,4V 3000mAh
MILO LED SA 2H MT 3000K LT	92768	450 lm	24W	SA (M)	2h	3000K	-	-25°C ÷ 40°C	LiFePO4 6,4V 3000mAh
MILO LED SA 2H MT 3000K MD LT	92767	450 lm	25W	SA (M)	2h	3000K	ON-OFF	-25°C ÷ 40°C	LiFePO4 6,4V 3000mAh
MILO LED SA 2H MT 3000K MDD LT	92766	450 lm	24W	SA (M)	2h	3000K	DIM	-25°C ÷ 40°C	LiFePO4 6,4V 3000mAh

MODELE STANDARDOWE / STANDARD MODELS

Model* / Model*	Numer katalogowy / Catalogue number	Strumień światła / Luminous flux	Źródło światła / Light source	Temperatura barwowa* / Colour temperature*	Czujnik Ruchu (MD) / Movement detector (MD)	Temperatura pracy / Working temperature
MILO LED 4000K	92789	1200 lm	13W	4000K	-	-25°C ÷ 40°C
MILO LED 4000K MD	92788	1200 lm	15W	4000K	ON-OFF	-25°C ÷ 40°C
MILO LED 4000K MDD	92787	1200 lm	14W	4000K	DIM	-25°C ÷ 40°C
MILO LED 3000K	92798	1200 lm	13W	3000K	-	-25°C ÷ 40°C
MILO LED 3000K MD	92797	1200 lm	15W	3000K	ON-OFF	-25°C ÷ 40°C
MILO LED 3000K MDD	92796	1200 lm	14W	3000K	DIM	-25°C ÷ 40°C

* Temperatury barwowe 5000K i 6500K na życzenie / 5000K or 6500K colour temperatures on request

** ON-OFF - czujnik ruchu typu włącz-wyłącz / On-o type movement detector
DIM - czujnik ruchu ściemniany / Dimmable type movement detector

TABELA ODSTĘPÓW DLA PŁASKICH DRÓG EWAKUACYJNYCH / SPACING TABLE FOR FLAT EVACUATION ROUTES

MILO LED SA 3H MT 4000K

Wysokość montażu (m) / Installation height (m)	1	2	3	4
2,5	4,1	10,6	10,6	4,1
3	4,4	12,0	12,0	4,6
4	4,7	12,5	12,5	4,7

WYKRESY STOŻKOWE / CONE DIAGRAMS

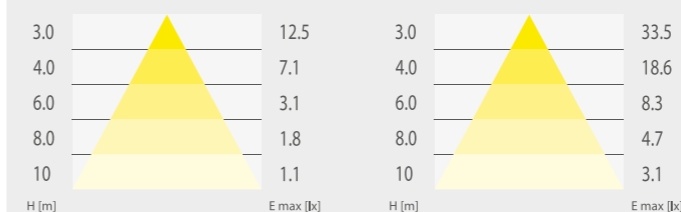

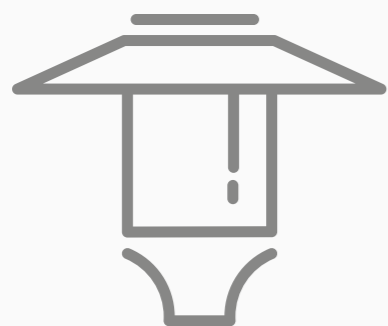

OPRAWY
ZEWNĘTRZNE
OUTDOOR
LUMINAIRES

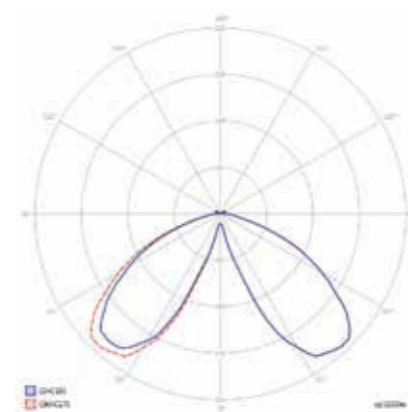

Promenad Led 30

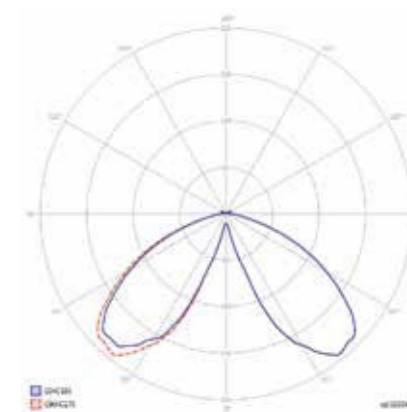

Promenad Led 40

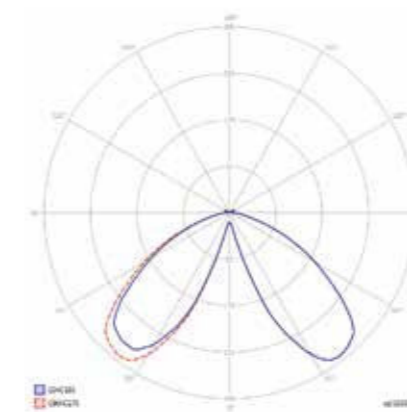

Promenad Led 60

Promenad LED



- Typ oprawy: do zastosowań zewnętrznych, do oświetlania terenów miejskich
- Klasa szczelności IP66
- Stopień ochrony drivera LED: IP67
- Konstrukcja: obudowa z wysokiej jakości poliwęglanu klasy V0, klosz przezroczysty ryflowany z PC klasy V0, odbłyśnik z blachy aluminiowej malowanej proszkowo
- Opcje klosza: przezroczysty, mleczny (opcja)
- Kolor lampy: szary RAL 7037 lub czarny RAL 9005
- Źródło LED: diody Cree* dużej mocy o wysokim strumieniu, radiator z odlewu aluminiowego, ilość LED-ów od 8 do 48 sztuk zależnie od mocy
- Standardowa barwa światła: 4000K, 3200K (opcja)
- Dostępna moc: od 20W do 60W
- Montaż: na standardowych słupach o średnicy zewnętrznej 60mm, 48mm lub 42mm
- Zastosowania: mała ulica, przestrzenie osiedlowe, tereny rekreacyjne
- Model asymetryczny do montażu wzdłuż elewacji
- Dekoracyjne oświetlenie w kolorze niebieskim, czerwonym lub zielonym jako opcja

* lub inne o zbliżonych parametrach

- Lamp type: for external applications, for lighting up urban areas
- IP66 protection rating
- LED driver protection level: IP67
- Construction: housing made of high quality polycarbonate V0 class, cover transparent rifflined made of PC V0 class, reflector made of aluminium powder painted
- Cover options: clear, opal (option)
- Lamp colour: gray RAL 7037 or black RAL 9005
- LED source: high power Cree LEDs with high luminous flux, heat sink made of aluminium cast, number of LEDs - from 8 to 48 pcs., depending on power
- Basic colour temperature: 4000K, 3200K (option)
- Available power: from 20W to 60W
- Installation: on standard poles with external diameter 60mm, 48mm or 42mm
- Applications: small streets, residential areas, recreation
- Asymmetric model designed for installation along the facade
- Decorative lighting in blue, red or green as an option

* or other brand with similar parameters

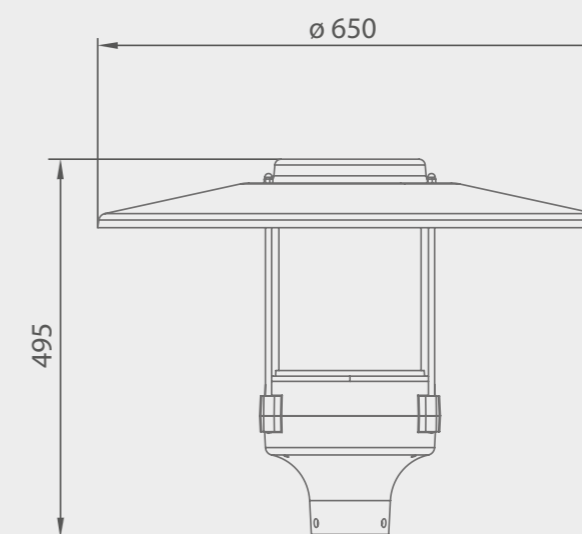

Model / Model	Numer katalogowy / Catalogue number		Moc / Power	Temp. barwowa / Colour temperature	Strumień lampy / Lamp luminous flux
	Czarna / Black	Szara / Gray			
Promenad LED 20	97633	97631	21W	4000K	1410 lm
Promenad LED 30	97625	97623	29W	4000K	2290 lm
Promenad LED 40	97617	97615	43W	4000K	3160 lm
Promenad LED 60	97570	97568	57W	4000K	4270 lm

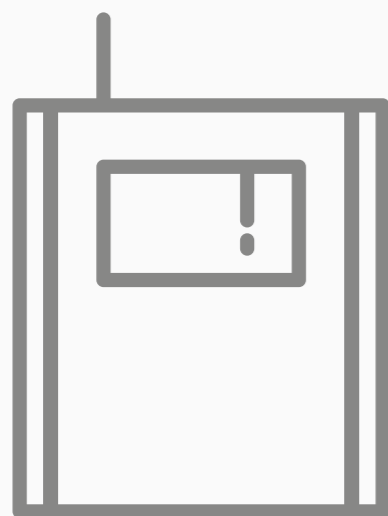

**SYSTEM
OŚWIETLENIA
AWARYJNEGO
EMERGENCY
LIGHTING
SYSTEM**



WELLS®

Wireless Emergency LED Lighting System

WELLS® – to najnowsze rozwiązanie opracowane przez Intelight Sp. z o.o., przeznaczone do bezprzewodowego monitorowania i zarządzania systemami oświetlenia awaryjnego w budynkach i obiektach.

Dzięki zastosowaniu stabilnej i dynamicznej komunikacji bezprzewodowej, adaptacja systemu WELLS® jest prosta i nie wymaga stosowania linii komunikacyjnych pomiędzy oprawami i urządzeniem sterującym, ani żadnych dodatkowych urządzeń przekazujących.

System sprawdzi się zarówno w nowych obiektach, gdzie niespotykana dotąd łatwość instalacji wpłynie na redukcję kosztów instalacji systemu monitorowania. Oraz w starszych, modernizowanych obiektach, gdzie brak konieczności prowadzenia dedykowanych linii komunikacyjnych będzie jeszcze większą zaletą.

System w wersji plug & play, może obsługiwać nawet do 235 opraw oświetlenia awaryjnego, bez konieczności jego prekonfiguracji.

System WELLS® jest kompatybilny z większością opraw awaryjnych produkowanych i oferowanych przez Intelight Sp. z o.o., jak również z zestawami awaryjnymi serii Primus LED HP, który umożliwia rozszerzenie funkcjonalności opraw oświetlenia podstawowego do funkcji świecenia awaryjnego i pełną funkcjonalność monitorowania i zarządzania w systemie WELLS®.

ZGODNY Z: PN-EN 62034

– Systemy automatycznego testowania awaryjnego oświetlenia ewakuacyjnego zasilanego z akumulatorów.

WELLS® - is the newest solution designed by INTELIGHT, dedicated for wireless monitoring of emergency lighting systems in public buildings.

Thanks to the stable and dynamic wireless communication applied, arrangement of the WELLS system is easy. Neither communication wires between luminaires and a central unit nor additional transmitters are needed.

The wireless communication system will be suitable both in new and existing buildings. In new buildings unprecedented ease of installation will decrease the total cost of the monitoring system. And in older buildings under retrofitting no need to install separate communication lines will turn out to be even a greater advantage.

A plug & play version of the system can operate even up to 235 emergency luminaires without a need for pre-configuration.

The WELLS system is compatible with most emergency luminaires manufactured by INTELIGHT, as well as with Primus LED HP emergency kits which allow for adding an emergency function with full WELLS control and monitoring functionalities to basic lighting fittings.

COMPLIANT TO: IEC 62034 / EN 62034

– Automatic test systems for battery powered emergency escape lighting.

TOPOLOGIA SYSTEMU / SYSTEM TOPOLOGY

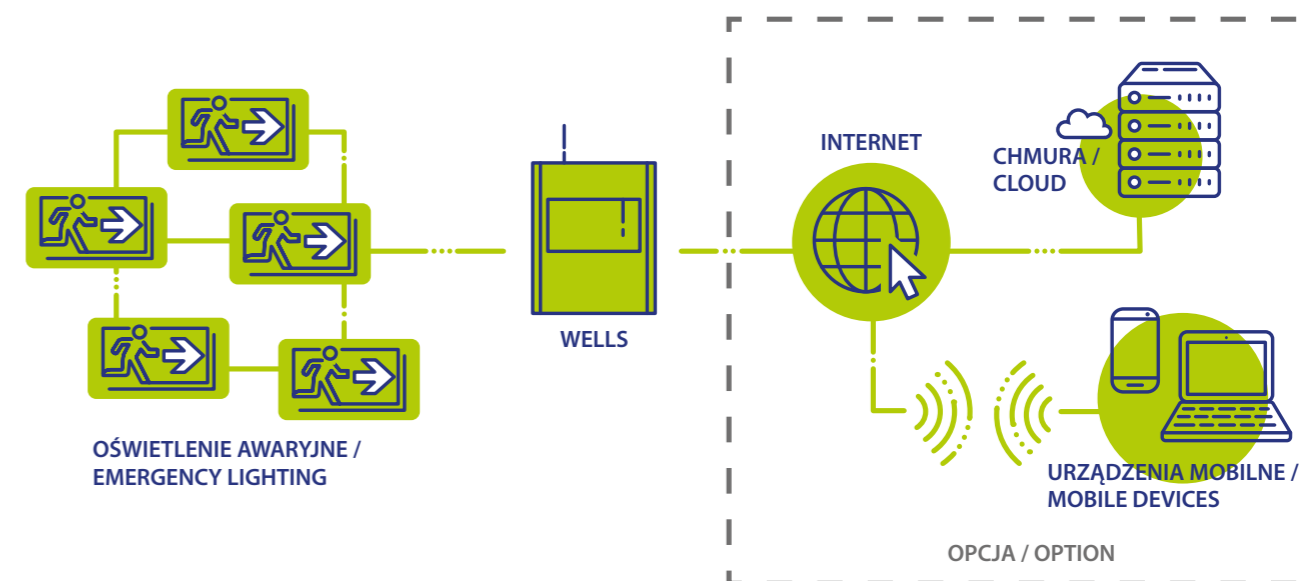

PODSTAWOWE CECHY SYSTEMU / GENERAL SYSTEM FEATURES





- Brak prekonfiguracji
 - Stabilna i niezawodna komunikacja radiowa w topologii mesh
 - Prosta instalacja
 - 7-Calowy ekran dotykowy i intuicyjne menu kafłowe
 - Komunikacja w paśmie 868 MHz / 916 MHz
 - Brak dodatkowych urządzeń adresujących i punktów dostępowych
 - Do 235 opraw w systemie plug & play
 - Bezpieczeństwo danych i systemu w przypadkach zaniku zasilania sieciowego
 - Możliwość zdalnego zarządzania oprawami z poziomu przeglądarki www
- No pre-configuration needed
 - Stable and reliable radio frequency communication in a mesh topology
 - Easy installation
 - 7-Inch touch screen and intuitive menu with tiles
 - 868 MHz / 916 MHz band communication
 - No additional address devices nor access points required
 - Up to 235 luminaires as plug & play
 - Safety of data and a system in a case of power failure
 - Possibility of remote control of luminaires through a web browser



WSPORNIK DO MONTAŻU ŚCIENNEGO / WALL MOUNTING BRACKET

Zastosowanie / Application	Numer katalogowy / Catalogue number		Zdjęcie / Photo	Rysunek techniczny / Technical drawing
	Numer / Number	Kolor / Colour		
OXIMIA	97437	Szary / Grey		
SUPREMA	94493	Biały / White		
SUPREMA	93926	Czarny / Black		

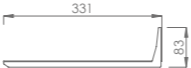

WSPORNIK DO MONTAŻU FLAGOWEGO / FLAG MOUNTING BRACKET

Zastosowanie / Application	Numer katalogowy / Catalogue number		Zdjęcie / Photo	Rysunek techniczny / Technical drawing
	Numer / Number	Kolor / Colour		
OXIMIA	97436	Szary / Grey		
SUPREMA	94494	Biały / White		
SUPREMA	93927	Czarny / Black		

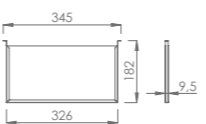

ZESTAW DS - PŁYTA PMMA / DS SET - PMMA PLATE

Zastosowanie / Application	Numer katalogowy / Catalogue number		Zdjęcie / Photo	Rysunek techniczny / Technical drawing
	Numer / Number	Kolor / Colour		
ORION LED 100	96414	Biały / White		
ORION LED 150	96413	Biały / White		
VELLA	93601	ND	-	



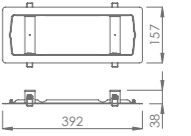

ZESTAW MONTAŻU ZWIESZANEGO / SUSPENDED MOUNTING KIT

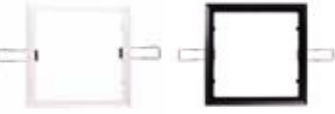
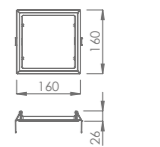
Zastosowanie / Application	Numer katalogowy / Catalogue number		Zdjęcie / Photo	Rysunek techniczny / Technical drawing
	Numer / Number	Kolor / Colour		
OXIMIA SUPREMA VELLA	96314 94492 94490	Srebrny / Silver		

ZESTAW MONTAŻU PODTYNKOWEGO / RECESSED MOUNTING KIT

Zastosowanie / Application	Numer katalogowy / Catalogue number		Zdjęcie / Photo	Rysunek techniczny / Technical drawing
	Numer / Number	Kolor / Colour		
ORION LED 100	96907	Biały / White		
VELLA	94491	Srebrny / Silver		-
STARLET QUAD	93001 92820	Biały / White Czarny / Black		

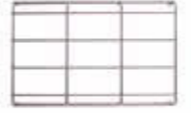
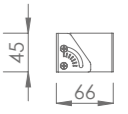
INNE / ANOTHER

Zastosowanie / Application	Numer katalogowy / Catalogue number		Zdjęcie / Photo	Rysunek techniczny / Technical drawing
	Numer / Number	Kolor / Colour		
OSŁONA OCHRONNA / PROTECTIVE CANOPY	91844	Biały / White		
ORION LED 150 VELLA	91843	Czarny / Black		
SIATKA OCHRONNA / PROTECTIVE GRID VELLA	91840	Srebrny / Silver		
ZESTAW MONTAŻU KĄTOWEGO / 0°-90° MOUNTING SUPPORT				
ORION LED 150 VELLA	93605	Biały / White		
ORION LED 150 VELLA	91992	Czarny / Black		
ZESTAW AKCESORIÓW ZASILANIA PRZELOTOWEGO / THROUGH WIRING KIT VELLA SUPREMA	92820	ND		-
ZESTAW GRZEWCZY LTR-25 8W / HEATING SET	93327	ND		-

AKUMULATORY NiCd / NiCd BATTERIES

Numer katalogowy / Catalogue number	Pakiet akumulatorów / Battery pack	Zastosowanie / Application	Konfiguracja / Arrangement	Wymiary (bez przewodów) / Dimensions (without wires)
96001	NiCd 3,6V 800mAh HT	KASJOPEJA LED 3H		L103 x Ø15
96856	NiCd 3,6V 1800mAh HT	ORION LED 100 MT 3H (41628) ORION LED 150 AT 3H (97245) ORION LED D AT 3H (94941)		L43 x W69 x H23
96002	NiCd 3,6V 1500mAh HT	ORION LED 150 MT 3H (98305) ORION LED D MT 3H (94942)		L129 x Ø23
94305	NiCd 3,6V 1500mAh HT	ORION LED 100 AT 3H (99905)		L43 x W69 x H23
93372	NiCd 3,6V 800mAh HT	OXIMIA LED (40095)		L153 x Ø15
96009	NiCd 3,6V 800mAh HT	STARLET EXTERNAL 3W 1H (93358, 93359)		L51 x W30 x H28
94913	NiCd 3,6V 3000mAh HT	STARLET WHITE 3W 3H (99616, 96740, 99355, 93353)		L186 x Ø35
94914	NiCd 3,6V 4500mAh HT	STARLET WHITE 5W 3H (99615, 99614, 93355, 93354)		L186 x Ø35
99811	NiCd 3,6V 1500mAh HT	PRIMUS TEC 6-36W /1H (97934)		L133 x Ø23
98243	Ni-Cd 4,8V 1500mAh HT	PRIMUS TEC 6-58W /1H (97933)		L178 x Ø23
40158	NiCd 3,6V 2500mAh HT	Wars Panel 2W 2H Cosmic LED 2H PRIMUS LED 2H /A PRIMUS TEC 6-36 2H		L150 x Ø27
40159	NiCd 3,6V 4000mAh HT	Wars Panel 2W 3H PRIMUS LED 3H /A PRIMUS TEC 6-36 3H		L186 x Ø35
40161	Ni-Cd 4,8V 2500mAh HT	PRIMUS TEC 6-58W 2H PRIMUS LED 2H/B		L200 x Ø27
40162	Ni-Cd 4,8V x D 4000mAh HT	PRIMUS TEC 6-58 3H PRIMUS LED 3H/B		L235 x Ø33
96000	NiCd 3,6V 600mAh	VELLA LED ECO 125 1H		L153 x Ø15
96008	NiCd 3,6V 1200mAh	VELLA LED ECO 125 3H		L129 x Ø23
96007	NiCd 3,6V 1000mAh	VELLA LED ECO 250 1H		L153 x Ø15
96005	NiCd 3,6V 2500mAh	VELLA LED ECO 250 3H		L150 x Ø27

AKUMULATORY NiMH / NiMH BATTERIES

Numer katalogowy / Catalogue number	Pakiet akumulatorów / Battery pack	Zastosowanie / Application	Konfiguracja / Arrangement	Wymiary (bez przewodów) / Dimensions (without wires)
96294	NiMH 3,6V 1500mAh HT	Carina LED 3H		L51 x W30 x H28
94972	NiMH 3,6V 3000mAh HT	Starlet External 3W 3H		(L43 x Ø23) + (L86 x Ø23)
94911	NiMH 3,6V 4000mAh HT	Starlet External 5W 3H		(L50 x Ø27) + (L100 x Ø23)

AKUMULATORY LiFePO4 6,4V / 6,4V LiFePO4 BATTERIES

Numer katalogowy / Catalogue number	Pakiet akumulatorów / Battery pack	Zastosowanie / Application	Konfiguracja / Arrangement	Wymiary (bez przewodów) / Dimensions (without wires)
96041	LiFePO4 6,4V 600mAh	VELLA LED 150 1H SUPREMA LED D-eco 3H		L150 x Ø14
96042	LiFePO4 6,4V 1500mAh	SUPREMA LED 150 3H SUPREMA LED D-std 3H		L130 x Ø18
96047	LiFePO4 6,4V 1500mAh	VELLA LED 150 3H VELLA LED 250 1H		L65 x W36 x H18
96045	LiFePO4 6,4V 3000mAh	SUPREMA LED 250 3H SUPREMA LED 350 3H SUPREMA LED 400 2H SUPREMA LED 650 2H		L130 x Ø26
96043	LiFePO4 6,4V 3000mAh	VELLA LED 250 3H VELLA LED 350 3H VELLA LED 400 2H VELLA LED 650 2H		L130 x W36 x H18

AKUMULATORY LiFePO4 12,8V / 12,8V LiFePO4 BATTERIES

Numer katalogowy / Catalogue number	Pakiet akumulatorów / Battery pack	Zastosowanie / Application	Konfiguracja / Arrangement	Wymiary (bez przewodów) / Dimensions (without wires)
96087	LiFePO4 12,8V 600mAh	WARS LED PANEL 3W 1H PRIMUS LED HP 3W 1H		L100 x W28 x H14
96088	LiFePO4 12,8V 1000mAh	WARS LED PANEL 3W 2H PRIMUS LED HP 3W 2H		L100 x W36 x H18
96089	LiFePO4 12,8V 1600mAh	WARS LED PANEL 3W 3H WARS LED PANEL 6W 2H PRIMUS LED HP 3W 3H PRIMUS LED HP 6W 2H		L130 x W36 x H18
96061	LiFePO4 12,8V 3000mAh	WARS LED PANEL 6W 3H WARS LED PANEL 9W 2h /3H WARS LED PANEL 12W 2H PRIMUS LED HP 6W 3H PRIMUS LED HP 9W 2h/ 3H PRIMUS LED HP 12W 2H		L260 x Ø26
96069	LiFePO4 12,8V 4000mAh	WARS LED PANEL 12W 3H PRIMUS LED HP 12W 3H		L292 x W36 x H18



WYJŚCIE W PRAWO W GÓRĘ /
EXIT UP TO THE RIGHT



WYJŚCIE W PRAWO W DÓŁ /
EXIT DOWN TO THE RIGHT



WYJŚCIE W GÓRĘ LEWO /
EXIT UP L



WYJŚCIE W DÓŁ LEWO /
EXIT DOWN L



WYJŚCIE W LEWO /
EXIT TO THE LEFT

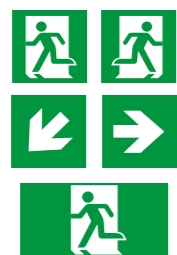

PIKTOGRAMY DO VELLA LED /
PICTOGRAM FOR VELLA LED



WYJŚCIE W LEWO W GÓRĘ /
EXIT UP TO THE LEFT



WYJŚCIE W LEWO W DÓŁ /
EXIT DOWN TO THE LEFT



WYJŚCIE W GÓRĘ PRAWO /
EXIT UP R



WYJŚCIE W DÓŁ PRAWO /
EXIT DOWN R



WYJŚCIE W PRAWO /
EXIT TO THE RIGHT



WYJŚCIE EWAKUACYJNE /
EVACUATION EXIT



HYDRANT WEWNĘTRZNY /
FIRE HOSE REEL

Zasilanie /
Power supply



Przystosowany do napięcia 230 V /
Adapted to the 230 V voltage



Zasilanie przystosowane do baterii centralnej /
Supply parameters for Central battery version

Rodzaj źródła światła /
Type of light source



Dioda elektroluminescencyjna /
Electroluminescent diode

Klasa odporności na wnikanie pyłu i wilgoci /
Dust and humidity resistance class



Miejsce stosowania /
Place of use



Wewnątrz /
Indoors



Wewnątrz i na zewnątrz /
Indoors and outdoors



Zewnątrz /
Indoors

Klasa ochronności przed porażeniem elektrycznym /
Electric shock protection class



Pierwsza klasa ochronności /
First protection class



Druga klasa ochronności /
Second protection class

Montaż na powierzchniach normalnie palnych /
Installation on normally flammable surfaces



Znak zgodności z dyrektywami Unii Europejskiej /
Marking of conformity with European Union directives



Czas pracy w trybie awaryjnym /
Emergency mode operating time



Zakres widoczności /
Visibility range



Stopień ochrony obudowy przed uszkodzeniami mechanicznymi /
Degree of enclosure protection against mechanical damages



Oprawa z funkcją testu /
Enclosure with test function



Test ręczny /
Manual test



Autotest /
Autotest



Test centralny /
Central test

Ochrona przed nadmiernym promieniowaniem UV /
Protection against excessive UV radiation



Wersja ze statecznikiem /
Version including ballast



Statecznik elektroniczny /
Electronic ballast





Statecznik magnetyczny /
Magnetic ballast



e-catalogue



 Gwiaździsta St. 19
01-651 Warsaw, Poland

 tel.: +48 22 100 35 10

 www.intelight.pl

 sprzedaz@intelight.pl
sales@intelight.pl